

# SCHISCHEK

A **rotork** Brand

## Schischek Explosionproof.

Protection of Life. Health. Assets.

# H V A C

### Product Catalogue

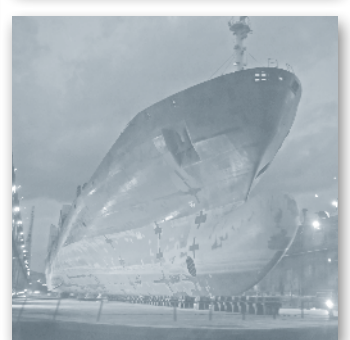
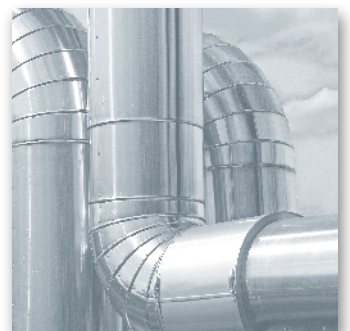

[www.schischek.com](http://www.schischek.com)

## Schischek Global Coverage

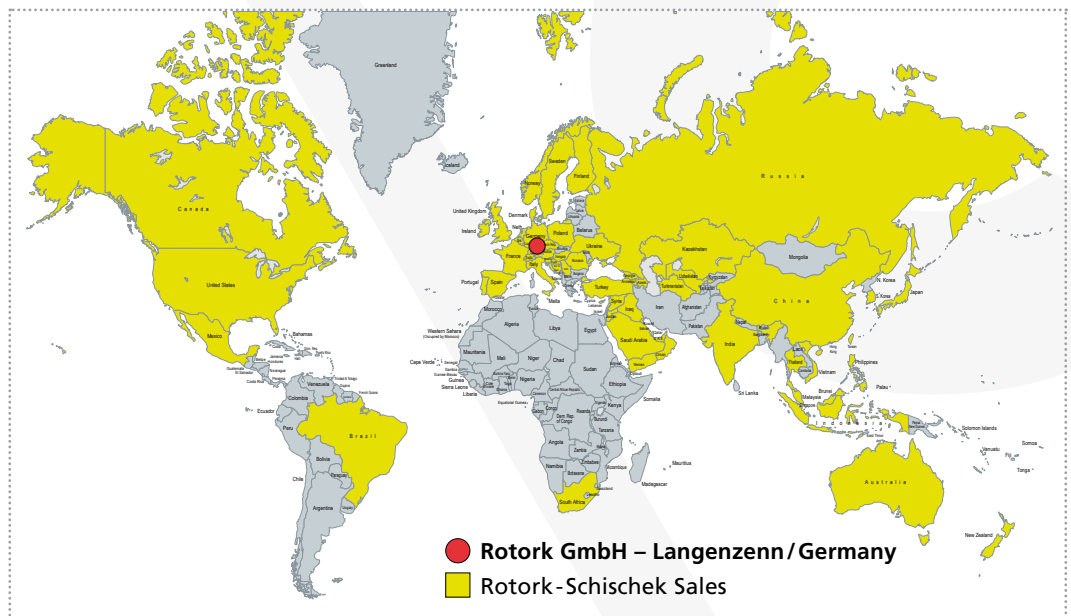

**Rotork GmbH**  
Muehlsteig 45  
90579 Langenzenn  
Germany  
Tel. +49 9101 9081-0  
Fax +49 9101 9081-77  
info@schischek.com  
www.schischek.com

**Rotork/Schischek contact worldwide:**  
[www.schischek.com/contact/rotork-schischek-worldwide](http://www.schischek.com/contact/rotork-schischek-worldwide)  
[www.rotork.com/en/contact-us/sales-service-locator](http://www.rotork.com/en/contact-us/sales-service-locator)



# Explosion protection is safety, worldwide, in thousands of applications!

## Explosion protection since 1975

Since 1975 Schischek has supplied electric explosion proof products worldwide for heating, ventilation and air-conditioning, for industrial and offshore applications.

Schischek Explosionproof has become an important partner for consultants, public authorities, control companies, installers, OEM's and, not least of all, the end user.

As supplier of components, we have always considered it our duty to develop products in conjunction with other control equipment. Modern Ex equipment, reliable, proven and with "state of the art" technology.

## Safety is essential

With this motto we state that explosion protection is not a question of statistics or half hearted solutions but that 100% safety must be guaranteed at all times. Explosion protection means taking on responsibility.

## There is no "little ex-protection"!

People have confidence in us as Ex protection specialists and in you as consultant, installer and contractor. All Schischek Ex products are, therefore, type-examination certified, approved by and produced according to the very latest standards and regulations. According to type and kind of protection, our products are suitable for operation in Ex areas, zones 0, 1, 2, 20, 21 and 22, including gases, vapours, mists and dusts – of course in accordance with ATEX directives.



Schischek supplies control companies and contractors in the Building Automation market. We have developed equipment which is compatible with nearly all control systems. By combining Schischek products with conventional switching and control equipment, reliable high quality systems are implemented that conform to Ex protection standards. Some examples of use are

fire and smoke dampers, paintspray areas, exhaust systems in chemical laboratories, battery rooms, sewage treatment plants, pumping stations etc.



Harsh environmental conditions and robust quality cause stringent design / construction requirements on components and materials. A fast closing electric actuator for fire / smoke dampers of less than 3 seconds is a requirement on oil and gas platforms as well as on FPSO's. After an intense development process including trials, a completely new concept in actuator engineering was produced.

Since, thousands of Schischek actuators in special aluminium and stainless steel housings or with offshore/marine coating have been delivered and installed, moreover, the product range has been continuously enlarged and refined.

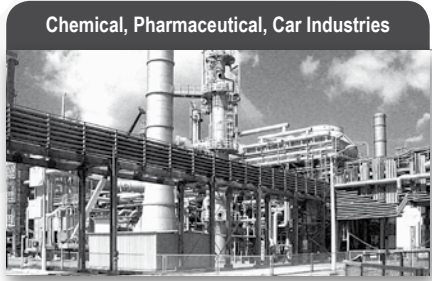

Whether you need air flow control in a pharmaceutical plant or temperature regulation of paint tanks in the car industry, Schischek offers cost-effective solutions specifically designed for control integration. Ex protection is required for applications from paint spray shops to drying stations. System compatibility with all aspects of control facilitates integrated planning from design to

completion. At the same time, safety and reliability increase in planning, installation, approval and operation. Since all equipment is maintenance-free, cost savings are realised.



In co-operation with valve and damper manufacturers, industrial control companies and contractors, Schischek products are in use worldwide. Our products are characterised by the "highest protection class, compact size and easy handling".

We can provide solutions to problems as far as Ex ventilation and precise temperature control in industrial plants are concerned.

## Which components have to be explosion proof?

In the diagram below, a typical air-handling system shows which equipment is allowed in the Ex area and which should only be placed in the safe area. The diagram does not claim to be complete.

If in doubt, please do not hesitate to consult us at Schischek. We will advise you in any case. A brief discussion in the early stages of planning can avoid substantial costs in remedial work later and gives you the peace of mind that you have a safely installed operating system.

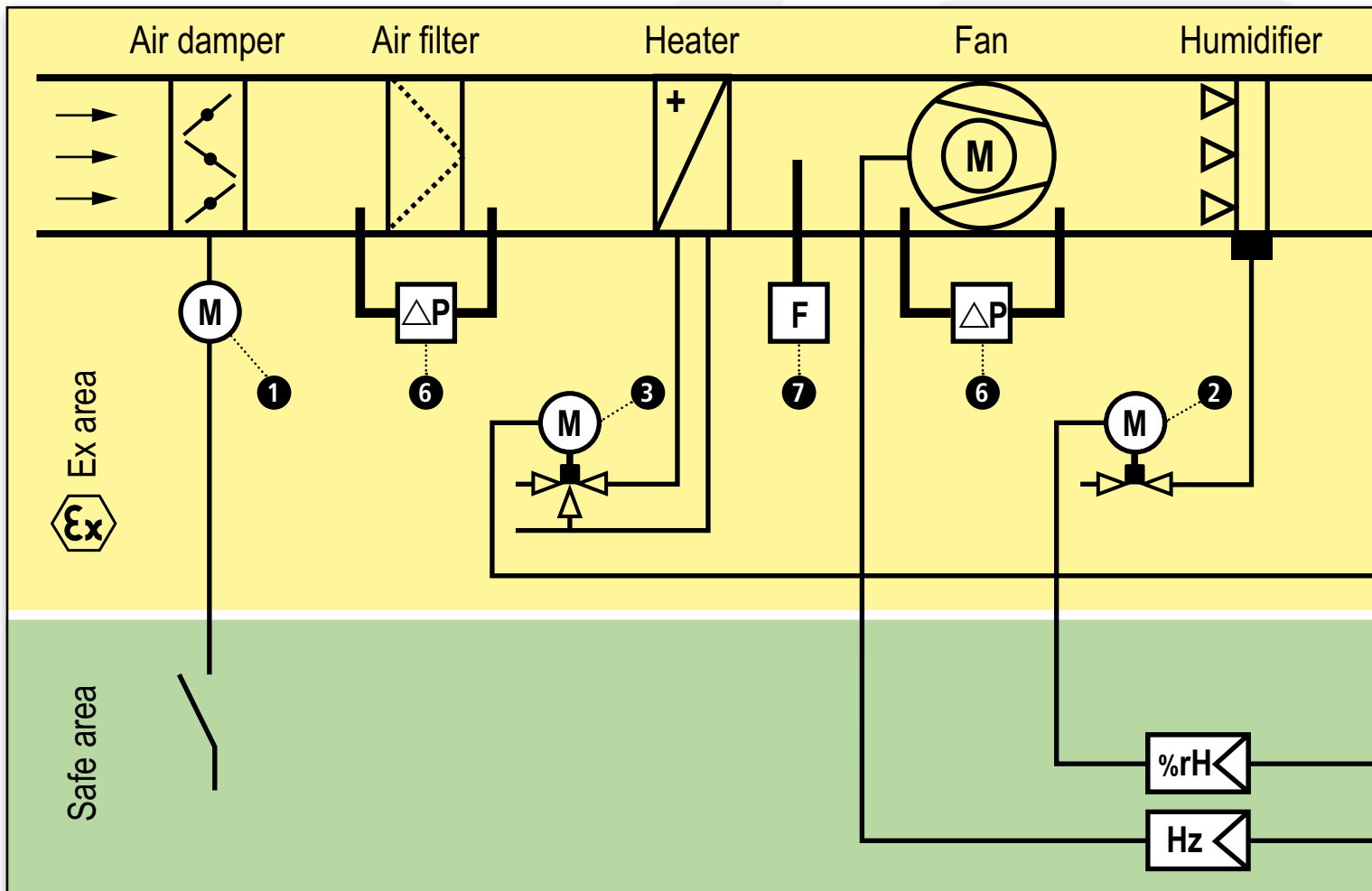

**1**

Quarter turn actuators for dampers and valves

**ExMax**  
**RedMax**



- 5...150 Nm
- 3...150 sec/90°
- On-off, 3-pos
- modulating
- with/without spring return

**2**

Failsafe linear valve actuators

**ExMax + LIN**  
**RedMax + LIN**



- 500...6.000 N
- 7,5...42 mm stroke
- 0,1...15 sec/mm
- On-off, 3-pos
- modulating
- with spring return

**3**

Linear valve actuators

**ExRun**  
**RedRun**



- 500...10.000 N
- 5...60 mm stroke
- 2...15 sec/mm
- On-off, 3-pos
- modulating

**4**

Temperature and humidity sensors

**ExCos-D**  
**RedCos-D**



- -40°C...+125°C
- 0...100 %rH
- full range adjustable



You should be aware of the areas of installation where an explosive atmosphere may build up. Furthermore, you should have the responsible authority classify the relevant Ex zone and in combination with type and condition of the explosive medium, you should be able to select suitable explosion proof equipment.

With Schischek products this is simple because all equipment is certified according to the highest safety standards – according to ATEX, of course!

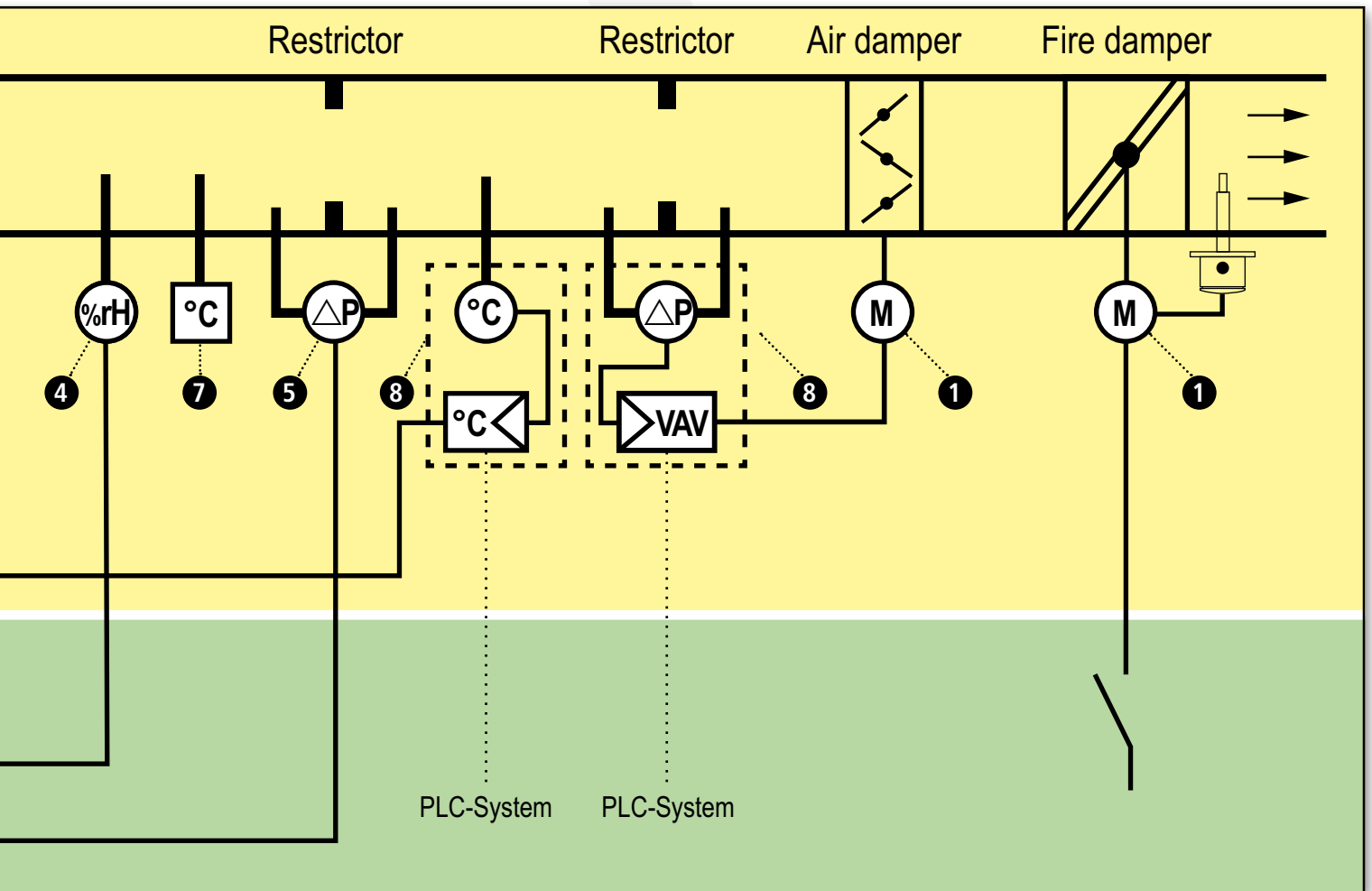

5

Pressure/differential pressure sensors

ExCos-P  
RedCos-P



- $\pm 100 \dots \pm 7.500$  Pa
- full range adjustable

6

Filter monitoring, fan belt protection

ExBin-P  
RedBin-P



- $0 \dots 5.000$  Pa
- Pressure/Differential pressure
- Fan-belt protection
- Filter protection
- 1- or 2-stage switching point

7

Thermostats, humidistats, Frost protection

ExBin-D  
RedBin-D



- $-40^{\circ}\text{C} \dots +125^{\circ}\text{C}$
- $0 \dots 100$  %rH
- 1- or 2-stage

ExBin-FR  
RedBin-FR

- $-10^{\circ}\text{C} \dots +15^{\circ}\text{C}$
- Capillary: 3 m, 6 m
- 1-stage switching point

8

Controller

ExReg-V  
Differential pressure



- $0 \dots 100$  Pa (VAV)
- $0 \dots 300$  Pa (VAV)
- $0 \dots 1.000$  Pa (VAV)

ExReg-D  
Temperature/Humidity

- $-40^{\circ}\text{C} \dots +125^{\circ}\text{C}$
- $0 \dots 100$  %rH

## Content overview

Product series						Installation areas							
						Gas 0	Dust 20	Gas 1	Dust 21	Gas 2	Dust 22	SA*	
<b>Quarter turn actuators 90°</b>													
ExMax	size S/M	5...	150 Nm	with /without spring return	10-11			●	●	●	●		
RedMax	size S/M	5...	150 Nm	with /without spring return	12-13					●	●		
InMax	size S/M	5...	150 Nm	with /without spring return	14-15								●
InMax	size L	150...	500 Nm	with /without spring return	16-17								●
<b>Linear valve actuators with spring return with 7,5/10/15/20/30/42 mm stroke (fixed)</b>													
LIN-.. + ExMax..	size S/M	500...	3.000 N	with spring return	20-21			●	●	●	●		
LIN-.. + RedMax..	size S/M	500...	3.000 N	with spring return	20-21					●	●		
LIN-.. + InMax..	size S/M	500...	3.000 N	with spring return	20-21								●
<b>Valve actuators with 5...60 mm stroke</b>													
ExRun	size S	500...	10.000 N	without spring return	22-23			●	●	●	●		
RedRun	size S	500...	10.000 N	without spring return	22-23					●	●		
InRun	size S	500...	10.000 N	without spring return	22-23								●
<b>Special options for actuators</b>													
Overview	special options for actuators				24-25								
ExPolar/ExArctic	heating system for actuators use in Ex areas down to -50/-60 °C				27			●	●	●	●		
InPolar/InArctic	heating system for actuators use in safe area down to -50/-60 °C				27								●
<b>Controller for VAV, pressure, temperature, humidity regulation</b>													
ExReg-V	volume flow and pressure controller	0...	1.000 Pa		30-31			●	●	●	●		
InReg-V	volume flow and pressure controller	0...	1.000 Pa		30-31					●	●		●
ExReg-D	temperature and humidity controller	-40...+125 °C/0...100 %rH			32-33			●	●	●	●		
InReg-D	temperature and humidity controller	-40...+125 °C/0...100 %rH			32-33								●
<b>Analog sensors for measuring of volume flow, temperature, humidity, pressure/differential pressure</b>													
ExCos-P	differential pressure, VAV sensors	± 100...	7.500 Pa		37			●	●	●	●		
RedCos-P	differential pressure, VAV sensors	± 100...	7.500 Pa		37					●	●		
InCos-P	differential pressure, VAV sensors	± 100...	7.500 Pa		37								●
ExCos-D	temperature and humidity transmitter for ExPro-C... sensors				38			●	●	●	●		
RedCos-D	temperature and humidity transmitter for ExPro-C... sensors				38					●	●		
InCos-D	temperature and humidity transmitter for InPro-C... sensors				38								●
ExPro-C...	temperature and humidity sensors for operation in HVAC systems				39			●	●	●	●		
InPro-C...	temperature and humidity sensors for operation in HVAC systems				39								●
ExLine/ExSens	transmitter EXL-IM-9182-... and analog, passive temperature-/humidity-/pressure sensors				40-41	●	●	●	●	●	●		●
<b>Switching sensors (thermostats, hygrostats, pressostats, fan belt protection, frost protection)</b>													
ExBin-P	pressure/differential pressure	0...	5.000 Pa		45			●	●	●	●		
RedBin-P	pressure/differential pressure	0...	5.000 Pa		45					●	●		
InBin-P	pressure/differential pressure	0...	5.000 Pa		45								●
ExBin-FR	frost protection thermostat	-10...	+15 °C		46			●	●	●	●		
RedBin-FR	frost protection thermostat	-10...	+15 °C		46					●	●		
InBin-FR	frost protection thermostat	-10...	+15 °C		46								●
ExBin-A	modules for adaptation of 1-2 passive, potential free, switching ExSens sensors				47			●	●	●	●		
RedBin-A	modules for adaptation of 1-2 passive, potential free, switching ExSens sensors				47					●	●		
InBin-A	modules for adaptation of 1-2 passive, potential free, switching ExSens sensors				47								●
ExBin-D	temperature and humidity thermostat for ExPro-B... sensors				48			●	●	●	●		
RedBin-D	temperature and humidity thermostat for ExPro-B... sensors				48					●	●		
InBin-D	temperature and humidity thermostat for InPro-B... sensors				48								●
ExPro-B...	thermostat/hygrostat sensors for operation in HVAC systems				49			●	●	●	●		
InPro-B...	thermostat/hygrostat sensors for operation in HVAC systems				49								●
ExLine/ExSens	switching module EXL-IR-9170-... and binary, passive temperature-/humidity-/pressure sensors				50-51	●	●	●	●	●	●		●
<b>Special options for sensors</b>													
Overview	special options for sensors				52								
ExPolar/ExArctic	heating system for sensors' use in Ex areas down to -40/-60 °C				53			●	●	●	●		
InPolar/InArctic	heating system for sensors' use in safe area down to -40/-60 °C				53								●
<b>Door holder magnets</b>													
ExMag	door holder magnets with 650, 1.300, 2.000 N force				54			●	●	●	●		
<b>Components</b>													
ExComp	different Ex-components, e.g. switches, push buttons, ...				54			●	●	●	●		

\*SA = Safe area

● = on request

<b>Additional information</b>	
Product codes/definitions	56-57
Installation according to ATEX (Zone system)	58
Installation according to NEC 500 (Division system, North America)	59
Valve automation	60-61
Certification information	62-63
Information about ATEX directives	64
Labelling of explosion proof equipment according to ATEX	65
Explosion proof informations	66
Information about zones, explosion groups and temperature classes	67
Ex applications	68-71
Rotork products (extraction) and service	72-77
Damper actuation focused	78-79

# Customer Support & Services **NEW** advanced offer!

## Warranty Extension



- Predictable safety and reliable service
- Transparent and flexible
- Budget hedging for EPCs

## Commissioning & On-Site Service



- Commissioning and technical briefing
- Examination and evaluation of installed products
- Troubleshooting and rectification

## Trainings & Seminars



- Basics explosion protection:
  - Certifications
  - Ignition protection types
  - Explosion protection specifications
- Schischek products and solutions:
  - Damper actuators
  - Valve actuators
  - Transmitters
- Facility layout in hazardous locations (HVAC)

## Conditions

Services	Specification of Services
12+12	12+12 warranty extension, 2,5% of net value of goods
12+24	12+24 warranty extension, 4% of net value of goods
Service	Commissioning: 10% of net value of goods or min. 100,- €
Service	On-site service: on request
Training	on request



## ExMax – Damper actuators for hazardous locations!

Quarter turn and rotary applications for damper control ...

HAZARDOUS LOCATIONS ZONE 1, 2, 21, 22

FAST SPRING RETURN TIME

UNIVERSAL POWER SUPPLY

STAINLESS STEEL SOLUTION

OFFSHORE / MARINE COATED VERSION

EASY INSTALLATION

COMPACT DIMENSIONS



**..Max Electrical drive engineering with 90° angle of rotation – Overview**

**Overview ..Max quarter turn actuators**

**Installation areas:**

**ExMax-** .....actuators for use in hazardous locations zone 1, 2, 21, 22

**RedMax-** .....actuators for use in hazardous locations zone 2, 22









**InMax-** .....actuators for use in safe area

**Application areas:**

**Ex/Red/InMax** .....for air and fire dampers, VAV control, ball valves, control dampers, ...

**The actuator concept offers obvious advantages:**

1. Small dimension, compact, easy installation, highest protection classes, cost effective
2. Universal power supply 24 to 240 Volt AC/DC, selfadjustable
3. With or without spring return (in acc. with type)
4. Robust aluminium housing, IP66, optional in stainless steel
5. Integrated heater for low temperatures
6. On site adjustable motor running time
7. Application also possible into harsh environment (stainless steel or offshore/marine coated)
8. Integrated manual override
9. Useful accessories such as retrofit limit switches
10. Actuators are direct coupling

		Actuators for air-dampers		ExMax-., RedMax-., InMax-.. ¼ turn actuators		
Nm	ExMax 	normal wiring		90° actuators from 5 to 150 Nm, with or w/o spring return (running time ~ 1, 3, 10, 20 s depending on type), for air-dampers.		
			Actuators for smoke- and fire-dampers		ExMax-., RedMax-., InMax-.. ¼ turn actuators	
				90° actuators from 5 to 150 Nm, with or w/o spring return (running time ~ 1, 3, 10, 20 s depending on type), for smoke- and fire-dampers.		
			Actuators for VAV control		ExMax-., RedMax-., InMax-.. ¼ turn actuators	
				90° actuators from 5 to 150 Nm, with or w/o spring return (running time ~ 1, 3, 10, 20 s depending on type), for VAV control.		
Actuators for ball valves		ExMax-., RedMax-., InMax-.. ¼ turn actuators				
Nm	ExMax 	normal wiring		90° actuators from 5 to 150 Nm, with or w/o spring return (running time ~ 1, 3, 10, 20 s depending on type), for ball valves.		
			Actuators for butterfly valves and other ¼ turn valves		ExMax-., RedMax-., InMax-.. ¼ turn actuators	
Nm	ExMax 	normal wiring		90° actuators from 5 to 150 Nm, with or w/o spring return (running time ~ 1, 3, 10, 20 s depending on type), for butterfly valves and other quarter turn valves.		
		Safe area	Ex area			

**ExMax 90° Ex quarter turn actuators size "S" for zone 1, 2, 21, 22****Explosion proof****Features of ExMax... size S**

ExMax..	Size S	Description	Basics
Zone 1, 2, 21, 22 Gas + Dust certified according to ATEX, IECEx, EAC, INMETRO, KOSHA UL*, CSA*, *...-A version only		ExMax are, in acc. with type, for automation of air dampers, fire and smoke dampers, volume control, as well as for ball valves, throttle valves and other quarter turn armatures.  <b>Delivery:</b> 1 actuator, ~ 1 m cable, allen key for manual override, 4 screws.	<ul style="list-style-type: none"> <li>• 24...240 VAC/DC self adaptable power supply</li> <li>• Up to 5 different running times adjustable on site</li> <li>• 95° angle of rotation (5° pretension)</li> <li>• 100% overload protected</li> <li>• Aluminium housing IP66, cable ~ 1 m</li> <li>• -40...+40°C/+50°C, integrated heater</li> <li>• Emergency manual override</li> <li>• Squared shaft connection 12 x 12 mm</li> <li>• Dimensions (H x W x D) 210 x 95 x 80 mm</li> </ul>

**Ex-d quarter turn actuators without spring return, 24 to 240 VAC/DC, for zone 1, 2, 21, 22**

Type	Torque	Running time 90°	Spring return	Control mode	Feedback	Features	Size
ExMax- 5.10	5 Nm / 10 Nm	3/15/30/60/120 sec.	-	On-off, 3-pos	-	-	S
ExMax-15.30	15 Nm / 30 Nm	3/15/30/60/120 sec.	-	On-off, 3-pos	-	-	S
ExMax- 5.10-S	5 Nm / 10 Nm	3/15/30/60/120 sec.	-	On-off, 3-pos	2 x aux. switches (5°/85°)	-	S
ExMax-15.30-S	15 Nm / 30 Nm	3/15/30/60/120 sec.	-	On-off, 3-pos	2 x aux. switches (5°/85°)	-	S
ExMax- 5.10-Y	5 Nm / 10 Nm	7,5/15/30/60/120 sec.	-	3-pos, 0...10 VDC, 4...20 mA	0...10 VDC, 4...20 mA	-	S
ExMax-15.30-Y	15 Nm / 30 Nm	7,5/15/30/60/120 sec.	-	3-pos, 0...10 VDC, 4...20 mA	0...10 VDC, 4...20 mA	-	S

**Ex-d quarter turn actuators with spring return, 24 to 240 VAC/DC, for zone 1, 2, 21, 22**

Type	Torque	Running time 90°	Spring return	Control mode	Feedback	Features	Size
ExMax-5.10- F	5 Nm / 10 Nm	3/15/30/60/120 sec.	~ 3 sec. / 10 sec.	On-off, 3-pos	-	-	S
ExMax- 15- F	15 Nm	3/15/30/60/120 sec.	~ 3 sec. / 10 sec.	On-off, 3-pos	-	-	S
ExMax-5.10-SF	5 Nm / 10 Nm	3/15/30/60/120 sec.	~ 3 sec. / 10 sec.	On-off, 3-pos	2 x aux. switches (5°/85°)	-	S
ExMax- 15-SF	15 Nm	3/15/30/60/120 sec.	~ 3 sec. / 10 sec.	On-off, 3-pos	2 x aux. switches (5°/85°)	-	S
ExMax-5.10-YF	5 Nm / 10 Nm	7,5/15/30/60/120 sec.	~ 3 sec. / 10 sec.	3-pos, 0...10 VDC, 4...20 mA	0...10 VDC, 4...20 mA	-	S
ExMax-15-YF	15 Nm	7,5/15/30/60/120 sec.	~ 3 sec. / 10 sec.	3-pos, 0...10 VDC, 4...20 mA	0...10 VDC, 4...20 mA	-	S
ExMax-5.10-BF	5 Nm / 10 Nm	3/15/30/60/120 sec.	~ 3 sec. / 10 sec.	On-off, 3-pos	2 x aux. switches (5°/85°)	ExPro-TT... connector	S
ExMax- 15-BF	15 Nm	3/15/30/60/120 sec.	~ 3 sec. / 10 sec.	On-off, 3-pos	2 x aux. switches (5°/85°)	ExPro-TT... connector	S

**Ex-d quarter turn actuators with fast spring return for Offshore application, 24 to 240 VAC/DC, for zone 1, 2, 21, 22**

Type	Torque	Running time 90°	Spring return*	Control mode	Feedback	Features	Size
ExMax- 8- F1	8 Nm	3/15/30/60/120 sec.	~ 1 sec.	On-off	-	-	S
ExMax-15- F1	15 Nm	3/15/30/60/120 sec.	~ 1 sec.	On-off	-	-	S
ExMax- 8-SF1	8 Nm	3/15/30/60/120 sec.	~ 1 sec.	On-off	2 x aux. switches (5°/85°)	-	S
ExMax-15-SF1	15 Nm	3/15/30/60/120 sec.	~ 1 sec.	On-off	2 x aux. switches (5°/85°)	-	S
ExMax- 8-BF1	8 Nm	3/15/30/60/120 sec.	~ 1 sec.	On-off	2 x aux. switches (5°/85°)	ExPro-TT... connector	S
ExMax-15-BF1	15 Nm	3/15/30/60/120 sec.	~ 1 sec.	On-off	2 x aux. switches (5°/85°)	ExPro-TT... connector	S

\*At temperatures below -20 °C, depending on the load, the spring return period can be up to 20 sec. If fast spring return below -20 °C is required, please contact our sales support. Please note that nominal values are also subject to tolerances.

**Accessories**

Type	Description/Technical data
ExSwitch	External, adaptable, on site adjustable Ex-d auxiliary switch with 2 potential free contacts, adaptable to ExMax.. actuators
ExBox-3P	Ex-e terminal box connectable to ExMax.. actuators with 1 cable for On-off or 3-pos operation
ExBox-3P/SW	Ex-e terminal box connectable to ExMax.. actuators with 1 cable for On-off or 3-pos operation + 2 cable for external aux. switches type ExSwitch
ExBox-Y/S	Ex-e terminal box connectable to ExMax.. actuators with 2 cable, for modulating operation or 3-pos + integrated switches (HS)
ExBox-Y/S/SW	Ex-e terminal box connectable to ExMax.. actuators with 2 cable, for modulating or 3-pos operation with feedback signal + 2 cable for external aux. switches
ExBox-BF	Ex-e terminal box connectable to ExMax.. actuators with 1 cable, for all ExMax...-BF
ExBox-BF/SW	Ex-e terminal box connectable to ExMax.. actuators with 1 cable, for all ExMax...-BF + 2 cable for external aux. switches type ExSwitch
MKK-S	Mounting bracket for ..Box-terminal boxes for direct coupling to ..Max.. actuators size S
KB-S	Mounting clamp for round damper shaft Ø 10 to 20 mm and squared shafts 10 to 16 mm, incl. bracket, connectable to all ExMax.. size S
KB-A	Shaft connection for damper shafts Ø ½", adaptable for all North American ..Max.. actuators size S
HV-SKU, HV-SLU	Manual override, connectable to actuators size S. HV-SKU = short version, HV-SLU = long version for add. mounting of ..Box/..Switch
AR-12-xx	Squared reduction part from 12 x 12 mm to shafts with 11 mm (type AR-12-11), 10 mm (type AR-12-10), 8 mm (type AR-12-08)
ExPro-TT-...	Safety temperature trigger for fire dampers, switching at 71°/72°C, with 1 m cable, suitable only for ExMax.../RedMax...-BF actuators!
EXC-DS1/VA	Safety temperature sensor for duct mounting, potential free contact, switching at 70°C...160°C (10°C steps)
DWB-S	Angle rotation limiter for mounting on actuator size S (details on request)
Retrofit-Kit-S	Mechanical adaptation for mounting on ..Max actuators size S, required to replace a previous type EXT15...-F1, EXT12...-F16, EXT15... or EXT30..
ADS	Different adaptations for different valves available. Please don't hesitate to ask for technical solution

Special options and offshore kits see page 25



## ExMax 90° Ex quarter turn actuators size "M" for zone 1, 2, 21, 22

### Explosion proof

### Features of ExMax-.. size M

ExMax-..	Size M	Description	Basics
Zone 1, 2, 21, 22 Gas + Dust certified according to ATEX, IECEx, EAC, INMETRO UL*, CSA*, *...-A version only		ExMax are, in acc. with type, for automation of air dampers, fire and smoke dampers, volume control, as well as for ball valves, throttle valves and other quarter turn armatures.  <b>Delivery:</b> 1 actuator, ~ 1 m cable, allen key for manual override, 4 screws.	<ul style="list-style-type: none"> <li>• 24...240 VAC/DC self adaptable power supply</li> <li>• Up to 5 different running times adjustable on site</li> <li>• 95° angle of rotation (5° pretension)</li> <li>• 100% overload protected</li> <li>• Aluminium housing IP67, cable ~ 1 m</li> <li>• -40...+40°C/+50°C, integrated heater</li> <li>• Emergency manual override</li> <li>• Squared shaft connection 16 × 16 mm</li> <li>• Dimensions (H × W × D) 288 × 149 × 116 mm</li> </ul>

### Ex-d quarter turn actuators without spring return, 24 to 240 VAC/DC, for zone 1, 2, 21, 22

Type	Torque	Running time 90°	Spring return	Control mode	Feedback	Features	Size
ExMax-50.75	50 Nm / 75 Nm	40/60/90/120/150 sec.	-	On-off, 3-pos	-	-	M
ExMax- 100	100 Nm	40/60/90/120/150 sec.	-	On-off, 3-pos	-	-	M
ExMax- 150	150 Nm	40/60/90/120 sec.	-	On-off, 3-pos	-	-	M
ExMax-50.75-S	50 Nm / 75 Nm	40/60/90/120/150 sec.	-	On-off, 3-pos	2 × aux. switches (5°/85°)	-	M
ExMax- 100-S	100 Nm	40/60/90/120/150 sec.	-	On-off, 3-pos	2 × aux. switches (5°/85°)	-	M
ExMax- 150-S	150 Nm	40/60/90/120 sec.	-	On-off, 3-pos	2 × aux. switches (5°/85°)	-	M
ExMax-50.75-Y	50 Nm / 75 Nm	40/60/90/120/150 sec.	-	3-pos, 0...10 VDC, 4...20 mA	0...10 VDC, 4...20 mA	-	M
ExMax- 100-Y	100 Nm	40/60/90/120/150 sec.	-	3-pos, 0...10 VDC, 4...20 mA	0...10 VDC, 4...20 mA	-	M

### Ex-d quarter turn actuators with spring return, 24 to 240 VAC/DC, for zone 1, 2, 21, 22

Type	Torque	Running time 90°	Spring return	Control mode	Feedback	Features	Size
ExMax-30- F	30 Nm	40/60/90/120/150 sec.	~ 20 sec.	On-off, 3-pos	-	-	M
ExMax-50- F	50 Nm	40/60/90/120/150 sec.	~ 20 sec.	On-off, 3-pos	-	-	M
ExMax-60- F	60 Nm	40/60/90/120 sec.	~ 20 sec.	On-off, 3-pos	-	-	M
ExMax-30-SF	30 Nm	40/60/90/120/150 sec.	~ 20 sec.	On-off, 3-pos	2 × aux. switches (5°/85°)	-	M
ExMax-50-SF	50 Nm	40/60/90/120/150 sec.	~ 20 sec.	On-off, 3-pos	2 × aux. switches (5°/85°)	-	M
ExMax-60-SF	60 Nm	40/60/90/120 sec.	~ 20 sec.	On-off, 3-pos	2 × aux. switches (5°/85°)	-	M
ExMax-30-YF	30 Nm	40/60/90/120/150 sec.	~ 20 sec.	3-pos, 0...10 VDC, 4...20 mA	0...10 VDC, 4...20 mA	-	M
ExMax-50-YF	50 Nm	40/60/90/120/150 sec.	~ 20 sec.	3-pos, 0...10 VDC, 4...20 mA	0...10 VDC, 4...20 mA	-	M
ExMax-30-BF	30 Nm	40/60/90/120/150 sec.	~ 20 sec.	On-off, 3-pos	2 × aux. switches (5°/85°)	ExPro-TT-.. connector	M
ExMax-50-BF	50 Nm	40/60/90/120/150 sec.	~ 20 sec.	On-off, 3-pos	2 × aux. switches (5°/85°)	ExPro-TT-.. connector	M
ExMax-60-BF	60 Nm	40/60/90/120 sec.	~ 20 sec.	On-off, 3-pos	2 × aux. switches (5°/85°)	ExPro-TT-.. connector	M

### Ex-d quarter turn actuators with fast spring return for Offshore application, 24 to 240 VAC/DC, for zone 1, 2, 21, 22

Type	Torque	Running time 90°	Spring return*	Control mode	Feedback	Features	Size
ExMax-30- F3	30 Nm	40/60/90/120/150 sec.	~ 3 sec.	On-off	-	-	M
ExMax-50- F3	50 Nm	40/60/90/120/150 sec.	~ 3 sec.	On-off	-	-	M
ExMax-30-SF3	30 Nm	40/60/90/120/150 sec.	~ 3 sec.	On-off	2 × aux. switches (5°/85°)	-	M
ExMax-50-SF3	50 Nm	40/60/90/120/150 sec.	~ 3 sec.	On-off	2 × aux. switches (5°/85°)	-	M
ExMax-30-BF3	30 Nm	40/60/90/120/150 sec.	~ 3 sec.	On-off	2 × aux. switches (5°/85°)	ExPro-TT-.. connector	M
ExMax-50-BF3	50 Nm	40/60/90/120/150 sec.	~ 3 sec.	On-off	2 × aux. switches (5°/85°)	ExPro-TT-.. connector	M

\*At temperatures below -20 °C, depending on the load, the spring return period can be up to 20 sec. If fast spring return below -20 °C is required, please contact our sales support. Please note that nominal values are also subject to tolerances.

### Accessories

Type	Description/Technical data
ExSwitch	External, adaptable, on site adjustable Ex-d auxiliary switch with 2 potential free contacts, adaptable to ExMax-.. actuators
ExBox-3P	Ex-e terminal box connectable to ExMax-.. actuators with 1 cable for On-off or 3-pos operation
ExBox-3P/SW	Ex-e terminal box connectable to ExMax-.. actuators with 1 cable for On-off or 3-pos operation + 2 cable for external aux. switches type ExSwitch
ExBox-Y/S	Ex-e terminal box connectable to ExMax-.. actuators with 2 cable, for modulating operation or 3-pos + integrated switches (HS)
ExBox-Y/S/SW	Ex-e terminal box connectable to ExMax-.. actuators with 2 cable, for modulating or 3-pos operation with feedback signal + 2 cable for external aux. switches
ExBox-BF	Ex-e terminal box connectable to ExMax-.. actuators with 1 cable, for all ExMax-...-BF
ExBox-BF/SW	Ex-e terminal box connectable to ExMax-.. actuators with 1 cable, for all ExMax-...-BF + 2 cable for external aux. switches type ExSwitch
MKK-M	Mounting bracket for ..Box-terminal boxes for direct coupling to ..Max-.. actuators size M
HV-MU	Manual override, connectable to actuators size M
AR-16-xx	Squared reduction part from 16 × 16 mm to shafts with 14 mm (type AR-16-14), 12 mm (type AR-16-12)
ExPro-TT-...	Safety temperature trigger for fire dampers, switching at 71°/72°C, with 1 m cable, suitable only for ExMax-../RedMax-...-BF actuators!
EXC-DS1/VA	Safety temperature sensor for duct mounting, potential free contact, switching at 70°C...160°C (10°C steps)
DWB-M	Angle rotation limiter for mounting on actuator size M
Retrofit-Kit-M	Mechanical adaptation for mounting on ..Max actuators size M, required to replace a previous type EXT30..-F3, EXT50..-F3 or EXT50..
ADM	Different adaptations for different valves available. Please don't hesitate to ask for technical solution

Special options and offshore kits see page 25

## RedMax 90° Ex quarter turn actuators "S" for zone 2, 22

Explosion proof

Features of RedMax... size S

RedMax..	Size S	Description	Basics
Zone 2, 22 Gas + Dust certified according to ATEX, IECEx, EAC, INMETRO, UL*, CSA*, *...A version only		RedMax are, in acc. with type, for automation of air dampers, fire and smoke dampers, volume control, as well as for ball valves, throttle valves and other quarter turn armatures.  <b>Delivery:</b> 1 actuator, ~ 1 m cable, allen key for manual override, 4 screws.	<ul style="list-style-type: none"> <li>• 24...240 VAC/DC self adaptable power supply</li> <li>• Up to 5 different running times adjustable on site</li> <li>• 95° angle of rotation (5° pretension)</li> <li>• 100% overload protected</li> <li>• Aluminium housing IP66, cable ~ 1 m</li> <li>• -40...+40°C/+50°C, integrated heater</li> <li>• Emergency manual override</li> <li>• Squared shaft connection 12 x 12 mm</li> <li>• Dimensions (H x W x D) 210 x 95 x 80 mm</li> </ul>

### Ex-d quarter turn actuators without spring return, 24 to 240 VAC/DC, for zone 2, 22

Type	Torque	Running time 90°	Spring return	Control mode	Feedback	Features	Size
RedMax- 5.10	5 Nm / 10 Nm	3/15/30/60/120 sec.	-	On-off, 3-pos	-	-	S
RedMax-15.30	15 Nm / 30 Nm	3/15/30/60/120 sec.	-	On-off, 3-pos	-	-	S
RedMax- 5.10-S	5 Nm / 10 Nm	3/15/30/60/120 sec.	-	On-off, 3-pos	2 x aux. switches (5°/85°)	-	S
RedMax-15.30-S	15 Nm / 30 Nm	3/15/30/60/120 sec.	-	On-off, 3-pos	2 x aux. switches (5°/85°)	-	S
RedMax- 5.10-Y	5 Nm / 10 Nm	7,5/15/30/60/120 sec.	-	3-pos, 0...10 VDC, 4...20 mA	0...10 VDC, 4...20 mA	-	S
RedMax-15.30-Y	15 Nm / 30 Nm	7,5/15/30/60/120 sec.	-	3-pos, 0...10 VDC, 4...20 mA	0...10 VDC, 4...20 mA	-	S

### Ex-d quarter turn actuators with spring return, 24 to 240 VAC/DC, for zone 2, 22

Type	Torque	Running time 90°	Spring return	Control mode	Feedback	Features	Size
RedMax-5.10- F	5 Nm / 10 Nm	3/15/30/60/120 sec.	~ 3 sec. / 10 sec.	On-off, 3-pos	-	-	S
RedMax- 15- F	15 Nm	3/15/30/60/120 sec.	~ 3 sec. / 10 sec.	On-off, 3-pos	-	-	S
RedMax-5.10-SF	5 Nm / 10 Nm	3/15/30/60/120 sec.	~ 3 sec. / 10 sec.	On-off, 3-pos	2 x aux. switches (5°/85°)	-	S
RedMax- 15-SF	15 Nm	3/15/30/60/120 sec.	~ 3 sec. / 10 sec.	On-off, 3-pos	2 x aux. switches (5°/85°)	-	S
RedMax-5.10-YF	5 Nm / 10 Nm	7,5/15/30/60/120 sec.	~ 3 sec. / 10 sec.	3-pos, 0...10 VDC, 4...20 mA	0...10 VDC, 4...20 mA	-	S
RedMax- 15-YF	15 Nm	7,5/15/30/60/120 sec.	~ 3 sec. / 10 sec.	3-pos, 0...10 VDC, 4...20 mA	0...10 VDC, 4...20 mA	-	S
RedMax-5.10-BF	5 Nm / 10 Nm	3/15/30/60/120 sec.	~ 3 sec. / 10 sec.	On-off, 3-pos	2 x aux. switches (5°/85°)	ExPro-TT... connector	S
RedMax- 15-BF	15 Nm	3/15/30/60/120 sec.	~ 3 sec. / 10 sec.	On-off, 3-pos	2 x aux. switches (5°/85°)	ExPro-TT... connector	S

### Ex-d quarter turn actuators with fast spring return for Offshore application, 24 to 240 VAC/DC, for zone 2, 22

Type	Torque	Running time 90°	Spring return*	Control mode	Feedback	Features	Size
RedMax- 8- F1	8 Nm	3/15/30/60/120 sec.	~ 1 sec.	On-off	-	-	S
RedMax-15- F1	15 Nm	3/15/30/60/120 sec.	~ 1 sec.	On-off	-	-	S
RedMax- 8-SF1	8 Nm	3/15/30/60/120 sec.	~ 1 sec.	On-off	2 x aux. switches (5°/85°)	-	S
RedMax-15-SF1	15 Nm	3/15/30/60/120 sec.	~ 1 sec.	On-off	2 x aux. switches (5°/85°)	-	S
RedMax- 8-BF1	8 Nm	3/15/30/60/120 sec.	~ 1 sec.	On-off	2 x aux. switches (5°/85°)	ExPro-TT... connector	S
RedMax-15-BF1	15 Nm	3/15/30/60/120 sec.	~ 1 sec.	On-off	2 x aux. switches (5°/85°)	ExPro-TT... connector	S

\*At temperatures below -20 °C, depending on the load, the spring return period can be up to 20 sec. If fast spring return below -20 °C is required, please contact our sales support. Please note that nominal values are also subject to tolerances.

### Accessories

Type	Description/Technical data
RedSwitch	External, adaptable, on site adjustable auxiliary switch with 2 potential free contacts, adaptable to RedMax... actuators
RedBox-3P	Ex-e terminal box connectable to RedMax... actuators with 1 cable for On-off or 3-pos operation
RedBox-3P/SW	Ex-e terminal box connectable to RedMax... actuators with 1 cable for On-off or 3-pos operation + 2 cable for external aux. switches type RedSwitch
RedBox-Y/S	Ex-e terminal box connectable to RedMax... actuators with 2 cable, for modulating operation or 3-pos + integrated switches (HS)
RedBox-Y/S/SW	Ex-e terminal box connectable to RedMax... actuators with 2 cable, for modulating or 3-pos operation with feedback signal + 2 cable for external aux. switches
RedBox-BF	Ex-e terminal box connectable to RedMax... actuators with 1 cable, for all RedMax...-BF
RedBox-BF/SW	Ex-e terminal box connectable to RedMax... actuators with 1 cable, for all RedMax...-BF + 2 cable for external aux. switches type RedSwitch
MKK-S	Mounting bracket for ..Box-terminal boxes for direct coupling to ..Max... actuators size S
KB-S	Mounting clamp for round damper shaft Ø 10 to 20 mm and squared shafts 10 to 16 mm, incl. bracket, connectable to all RedMax... size S
KB-A	Shaft connection for damper shafts Ø ½", adaptable for all North American ..Max... actuators size S
HV-SKU, HV-SLU	Manual override, connectable to actuators size S. HV-SKU = short version, HV-SLU = long version for add. mounting of ..Box/..Switch
AR-12-xx	Squared reduction part from 12 x 12 mm to shafts with 11 mm (type AR-12-11), 10 mm (type AR-12-10), 8 mm (type AR-12-08)
ExPro-TT...	Safety temperature trigger for fire dampers, switching at 71°/72°C, with 1 m cable, suitable only for ExMax.../RedMax...-BF actuators!
EXC-DS1/VA	Safety temperature sensor for duct mounting, potential free contact, switching at 70°C...160°C (10°C steps)
DWB-S	Angle rotation limiter for mounting on actuator size S (details on request)
Retrofit-Kit-S	Mechanical adaptation for mounting on ..Max actuators size S, required to replace a previous type EXT15...-F1, EXT12...-F16, EXT15... or EXT30..
ADS	Different adaptations for different valves available. Please don't hesitate to ask for technical solution

Special options and offshore kits see page 25

## RedMax 90° Ex quarter turn actuators "M" for zone 2, 22

Explosion proof

Features of RedMax.. size M

RedMax..	Size M	Description	Basics
Zone 2, 22 Gas + Dust certified according to ATEX, IECEx, EAC, INMETRO, UL*, CSA*, *...A version only		RedMax are, in acc. with type, for automation of air dampers, fire and smoke dampers, volume control, as well as for ball valves, throttle valves and other quarter turn armatures.  <b>Delivery:</b> 1 actuator, ~ 1 m cable, allen key for manual override, 4 screws.	<ul style="list-style-type: none"> <li>• 24...240 VAC/DC self adaptable power supply</li> <li>• Up to 5 different running times adjustable on site</li> <li>• 95° angle of rotation (5° pretension)</li> <li>• 100% overload protected</li> <li>• Aluminium housing IP67, cable ~ 1 m</li> <li>• -40...+40°C/+50°C, integrated heater</li> <li>• Emergency manual override</li> <li>• Squared shaft connection 16 × 16 mm</li> <li>• Dimensions (H × W × D) 288 × 149 × 116 mm</li> </ul>

### Ex-d quarter turn actuators without spring return, 24 to 240 VAC/DC, for zone 2, 22

Type	Torque	Running time 90°	Spring return	Control mode	Feedback	Features	Size
RedMax-50.75	50 Nm / 75 Nm	40/60/90/120/150 sec.	-	On-off, 3-pos	-	-	M
RedMax- 100	100 Nm	40/60/90/120/150 sec.	-	On-off, 3-pos	-	-	M
RedMax- 150	150 Nm	40/60/90/120 sec.	-	On-off, 3-pos	-	-	M
RedMax-50.75-S	50 Nm / 75 Nm	40/60/90/120/150 sec.	-	On-off, 3-pos	2 × aux. switches (5°/85°)	-	M
RedMax- 100-S	100 Nm	40/60/90/120/150 sec.	-	On-off, 3-pos	2 × aux. switches (5°/85°)	-	M
RedMax- 150-S	150 Nm	40/60/90/120 sec.	-	On-off, 3-pos	2 × aux. switches (5°/85°)	-	M
RedMax-50.75-Y	50 Nm / 75 Nm	40/60/90/120/150 sec.	-	3-pos, 0...10 VDC, 4...20 mA	0...10 VDC, 4...20 mA	-	M
RedMax- 100-Y	100 Nm	40/60/90/120/150 sec.	-	3-pos, 0...10 VDC, 4...20 mA	0...10 VDC, 4...20 mA	-	M

### Ex-d quarter turn actuators with spring return, 24 to 240 VAC/DC, for zone 2, 22

Type	Torque	Running time 90°	Spring return	Control mode	Feedback	Features	Size
RedMax-30- F	30 Nm	40/60/90/120/150 sec.	~ 20 sec.	On-off, 3-pos	-	-	M
RedMax-50- F	50 Nm	40/60/90/120/150 sec.	~ 20 sec.	On-off, 3-pos	-	-	M
RedMax-60- F	60 Nm	40/60/90/120 sec.	~ 20 sec.	On-off, 3-pos	-	-	M
RedMax-30-SF	30 Nm	40/60/90/120/150 sec.	~ 20 sec.	On-off, 3-pos	2 × aux. switches (5°/85°)	-	M
RedMax-50-SF	50 Nm	40/60/90/120/150 sec.	~ 20 sec.	On-off, 3-pos	2 × aux. switches (5°/85°)	-	M
RedMax-60-SF	60 Nm	40/60/90/120 sec.	~ 20 sec.	On-off, 3-pos	2 × aux. switches (5°/85°)	-	M
RedMax-30-YF	30 Nm	40/60/90/120/150 sec.	~ 20 sec.	3-pos, 0...10 VDC, 4...20 mA	0...10 VDC, 4...20 mA	-	M
RedMax-50-YF	50 Nm	40/60/90/120/150 sec.	~ 20 sec.	3-pos, 0...10 VDC, 4...20 mA	0...10 VDC, 4...20 mA	-	M
RedMax-30-BF	30 Nm	40/60/90/120/150 sec.	~ 20 sec.	On-off, 3-pos	2 × aux. switches (5°/85°)	ExPro-TT.. connector	M
RedMax-50-BF	50 Nm	40/60/90/120/150 sec.	~ 20 sec.	On-off, 3-pos	2 × aux. switches (5°/85°)	ExPro-TT.. connector	M
RedMax-60-BF	60 Nm	40/60/90/120 sec.	~ 20 sec.	On-off, 3-pos	2 × aux. switches (5°/85°)	ExPro-TT.. connector	M

### Ex-d quarter turn actuators with fast spring return for Offshore application, 24 to 240 VAC/DC, for zone 2, 22

Type	Torque	Running time 90°	Spring return*	Control mode	Feedback	Features	Size
RedMax-30- F3	30 Nm	40/60/90/120/150 sec.	~ 3 sec.	On-off	-	-	M
RedMax-50- F3	50 Nm	40/60/90/120/150 sec.	~ 3 sec.	On-off	-	-	M
RedMax-30-SF3	30 Nm	40/60/90/120/150 sec.	~ 3 sec.	On-off	2 × aux. switches (5°/85°)	-	M
RedMax-50-SF3	50 Nm	40/60/90/120/150 sec.	~ 3 sec.	On-off	2 × aux. switches (5°/85°)	-	M
RedMax-30-BF3	30 Nm	40/60/90/120/150 sec.	~ 3 sec.	On-off	2 × aux. switches (5°/85°)	ExPro-TT.. connector	M
RedMax-50-BF3	50 Nm	40/60/90/120/150 sec.	~ 3 sec.	On-off	2 × aux. switches (5°/85°)	ExPro-TT.. connector	M

\*At temperatures below -20 °C, depending on the load, the spring return period can be up to 20 sec. If fast spring return below -20 °C is required, please contact our sales support. Please note that nominal values are also subject to tolerances.

### Accessories

Type	Description/Technical data
RedSwitch	External, adaptable, on site adjustable auxiliary switch with 2 potential free contacts, adaptable to RedMax.. actuators
RedBox-3P	Ex-e terminal box connectable to RedMax.. actuators with 1 cable for On-off or 3-pos operation
RedBox-3P/SW	Ex-e terminal box connectable to RedMax.. actuators with 1 cable for On-off or 3-pos operation + 2 cable for external aux. switches type RedSwitch
RedBox-Y/S	Ex-e terminal box connectable to RedMax.. actuators with 2 cable, for modulating operation or 3-pos + integrated switches (HS)
RedBox-Y/S/SW	Ex-e terminal box connectable to RedMax.. actuators with 2 cable, for modulating or 3-pos operation with feedback signal + 2 cable for external aux. switches
RedBox-BF	Ex-e terminal box connectable to RedMax.. actuators with 1 cable, for all RedMax...-BF
RedBox-BF/SW	Ex-e terminal box connectable to RedMax.. actuators with 1 cable, for all RedMax...-BF + 2 cable for external aux. switches type RedSwitch
MKK-M	Mounting bracket for ..Box-terminal boxes for direct coupling to ..Max.. actuators size M
HV-MU	Manual override, connectable to actuators size M
AR-16-xx	Squared reduction part from 16 × 16 mm to shafts with 14 mm (type AR-16-14), 12 mm (type AR-16-12)
ExPro-TT...	Safety temperature trigger for fire dampers, switching at 71°/72°C, with 1 m cable, suitable only for ExMax.../RedMax...-BF actuators!
EXC-DS1/VA	Safety temperature sensor for duct mounting, potential free contact, switching at 70°C...160°C (10°C steps)
DWB-M	Angle rotation limiter for mounting on actuator size M
Retrofit-Kit-M	Mechanical adaptation for mounting on ..Max actuators size M, required to replace a previous type EXT30..F3, EXT50..F3 or EXT50..
ADM	Different adaptations for different valves available. Please don't hesitate to ask for technical solution

Special options and offshore kits see page 25



## InMax 90° quarter turn actuators "S" for safe area

Industrial

Features of InMax-.. size S

InMax-..	Size S	Description	Basics
NOT Explosion proof and only for use in safe area IP66		InMax are, in acc. with type, for automation of air dampers, fire and smoke dampers, volume control, as well as for ball valves, throttle valves and other quarter turn armatures.  <b>Delivery:</b> 1 actuator, ~ 1 m cable, allen key for manual override, 4 screws.	<ul style="list-style-type: none"> <li>• 24...240 VAC/DC self adaptable power supply</li> <li>• Up to 5 different running times adjustable on site</li> <li>• 95° angle of rotation (5° pretension)</li> <li>• 100% overload protected</li> <li>• Aluminium housing IP66, cable ~ 1 m</li> <li>• -40...+50°C, integrated heater</li> <li>• Emergency manual override</li> <li>• Squared shaft connection 12 x 12 mm</li> <li>• Dimensions (H x W x D) 210 x 95 x 80 mm</li> </ul>

### Quarter turn actuators without spring return, 24 to 240 VAC/DC, for safe area

Type	Torque	Running time 90°	Spring return	Control mode	Feedback	Features	Size
InMax- 5.10	5 Nm / 10 Nm	3/15/30/60/120 sec.	-	On-off, 3-pos	-	-	S
InMax-15.30	15 Nm / 30 Nm	3/15/30/60/120 sec.	-	On-off, 3-pos	-	-	S
InMax- 5.10-S	5 Nm / 10 Nm	3/15/30/60/120 sec.	-	On-off, 3-pos	2 x aux. switches (5°/85°)	-	S
InMax-15.30-S	15 Nm / 30 Nm	3/15/30/60/120 sec.	-	On-off, 3-pos	2 x aux. switches (5°/85°)	-	S
InMax- 5.10-Y	5 Nm / 10 Nm	7,5/15/30/60/120 sec.	-	3-pos, 0...10 VDC, 4...20 mA	0...10 VDC, 4...20 mA	-	S
InMax-15.30-Y	15 Nm / 30 Nm	7,5/15/30/60/120 sec.	-	3-pos, 0...10 VDC, 4...20 mA	0...10 VDC, 4...20 mA	-	S

### Quarter turn actuators with spring return, 24 to 240 VAC/DC, for safe area

Type	Torque	Running time 90°	Spring return	Control mode	Feedback	Features	Size
InMax-5.10-F	5 Nm / 10 Nm	3/15/30/60/120 sec.	~ 3 sec. / 10 sec.	On-off, 3-pos	-	-	S
InMax- 15-F	15 Nm	3/15/30/60/120 sec.	~ 3 sec. / 10 sec.	On-off, 3-pos	-	-	S
InMax-5.10-SF	5 Nm / 10 Nm	3/15/30/60/120 sec.	~ 3 sec. / 10 sec.	On-off, 3-pos	2 x aux. switches (5°/85°)	-	S
InMax- 15-SF	15 Nm	3/15/30/60/120 sec.	~ 3 sec. / 10 sec.	On-off, 3-pos	2 x aux. switches (5°/85°)	-	S
InMax-5.10-YF	5 Nm / 10 Nm	7,5/15/30/60/120 sec.	~ 3 sec. / 10 sec.	3-pos, 0...10 VDC, 4...20 mA	0...10 VDC, 4...20 mA	-	S
InMax- 15-YF	15 Nm	7,5/15/30/60/120 sec.	~ 3 sec. / 10 sec.	3-pos, 0...10 VDC, 4...20 mA	0...10 VDC, 4...20 mA	-	S
InMax-5.10-BF	5 Nm / 10 Nm	3/15/30/60/120 sec.	~ 3 sec. / 10 sec.	On-off, 3-pos	2 x aux. switches (5°/85°)	InPro-TT... connector	S
InMax- 15-BF	15 Nm	3/15/30/60/120 sec.	~ 3 sec. / 10 sec.	On-off, 3-pos	2 x aux. switches (5°/85°)	InPro-TT... connector	S

### Quarter turn actuators with fast spring return for Offshore application, 24 to 240 VAC/DC, for safe area

Type	Torque	Running time 90°	Spring return*	Control mode	Feedback	Features	Size
InMax- 8-F1	8 Nm	3/15/30/60/120 sec.	~ 1 sec.	On-off	-	-	S
InMax-15-F1	15 Nm	3/15/30/60/120 sec.	~ 1 sec.	On-off	-	-	S
InMax- 8-SF1	8 Nm	3/15/30/60/120 sec.	~ 1 sec.	On-off	2 x aux. switches (5°/85°)	-	S
InMax-15-SF1	15 Nm	3/15/30/60/120 sec.	~ 1 sec.	On-off	2 x aux. switches (5°/85°)	-	S
InMax- 8-BF1	8 Nm	3/15/30/60/120 sec.	~ 1 sec.	On-off	2 x aux. switches (5°/85°)	InPro-TT... connector	S
InMax-15-BF1	15 Nm	3/15/30/60/120 sec.	~ 1 sec.	On-off	2 x aux. switches (5°/85°)	InPro-TT... connector	S

\*At temperatures below -20 °C, depending on the load, the spring return period can be up to 20 sec. If fast spring return below -20 °C is required, please contact our sales support. Please note that nominal values are also subject to tolerances.

### Accessories

Type	Description/Technical data
InSwitch	External, adaptable, on site adjustable auxiliary switch with 2 potential free contacts, adaptable to InMax-.. actuators
InBox-3P	Terminal box connectable to InMax-.. actuators with 1 cable for On-off or 3-pos operation
InBox-3P/SW	Terminal box connectable to InMax-.. actuators with 1 cable for On-off or 3-pos operation + 2 cable for external aux. switches type InSwitch
InBox-Y/S	Terminal box connectable to InMax-.. actuators with 2 cable, for modulating operation or 3-pos + integrated switches (HS)
InBox-Y/S/SW	Terminal box connectable to InMax-.. actuators with 2 cable, for modulating or 3-pos operation with feedback signal + 2 cable for external aux. switches
InBox-BF	Terminal box connectable to InMax-.. actuators with 1 cable, for all InMax-...-BF
InBox-BF/SW	Terminal box connectable to InMax-.. actuators with 1 cable, for all InMax-...-BF + 2 cable for external aux. switches type InSwitch
MKK-S	Mounting bracket for ..Box-terminal boxes for direct coupling to ..Max-.. actuators size S
KB-S	Mounting clamp for round damper shaft Ø 10 to 20 mm and squared shafts 10 to 16 mm, incl. bracket, connectable to all InMax-.. size S
KB-A	Shaft connection for damper shafts Ø ½", adaptable for all North American ..Max-.. actuators size S
HV-SKU, HV-SLU	Manual override, connectable to actuators size S. HV-SKU = short version, HV-SLU = long version for add. mounting of ..Box/..Switch
AR-12-xx	Squared reduction part from 12 x 12 mm to shafts with 11 mm (type AR-12-11), 10 mm (type AR-12-10), 8 mm (type AR-12-08)
InPro-TT...	Safety temperature trigger for fire dampers, switching at 71°/72°C, with 1 m cable, suitable only for InMax-...-BF actuators!
EXC-DS1/VA	Safety temperature sensor for duct mounting, potential free contact, switching at 70°C...160°C (10°C steps)
DWB-S	Angle rotation limiter for mounting on actuator size S (details on request)
Retrofit-Kit-S	Mechanical adaptation for mounting on ..Max actuators size S, required to replace a previous type NOT15..-F1, NOT12..-F16, NOT15.. or NOT30..
ADS	Different adaptations for different valves available. Please don't hesitate to ask for technical solution

Special options and offshore kits see page 25

## InMax 90° quarter turn actuators "M" for safe area

Industrial

Features of InMax-.. size M

InMax-..	Size M	Description	Basics
NOT Explosion proof and only for use in safe area IP67		InMax are, in acc. with type, for automation of air dampers, fire and smoke dampers, volume control, as well as for ball valves, throttle valves and other quarter turn armatures.  <b>Delivery:</b> 1 actuator, ~ 1 m cable, allen key for manual override, 4 screws.	<ul style="list-style-type: none"> <li>• <b>24...240 VAC/DC</b> self adaptable power supply</li> <li>• Up to 5 different running times adjustable on site</li> <li>• 95° angle of rotation (5° pretension)</li> <li>• 100% overload protected</li> <li>• Aluminium housing IP67, cable ~ 1 m</li> <li>• -40...+50°C, integrated heater</li> <li>• Emergency manual override</li> <li>• Squared shaft connection 16 x 16 mm</li> <li>• Dimensions (H x W x D) 288 x 149 x 116 mm</li> </ul>

### Quarter turn actuators without spring return, 24 to 240 VAC/DC, for safe area

Type	Torque	Running time 90°	Spring return	Control mode	Feedback	Features	Size
InMax-50.75	50 Nm / 75 Nm	40/60/90/120/150 sec.	-	On-off, 3-pos	-	-	M
InMax- 100	100 Nm	40/60/90/120/150 sec.	-	On-off, 3-pos	-	-	M
InMax- 150	150 Nm	40/60/90/120 sec.	-	On-off, 3-pos	-	-	M
InMax-50.75-S	50 Nm / 75 Nm	40/60/90/120/150 sec.	-	On-off, 3-pos	2 x aux. switches (5°/85°)	-	M
InMax- 100-S	100 Nm	40/60/90/120/150 sec.	-	On-off, 3-pos	2 x aux. switches (5°/85°)	-	M
InMax- 150-S	150 Nm	40/60/90/120 sec.	-	On-off, 3-pos	2 x aux. switches (5°/85°)	-	M
InMax-50.75-Y	50 Nm / 75 Nm	40/60/90/120/150 sec.	-	3-pos, 0...10 VDC, 4...20 mA	0...10 VDC, 4...20 mA	-	M
InMax- 100-Y	100 Nm	40/60/90/120/150 sec.	-	3-pos, 0...10 VDC, 4...20 mA	0...10 VDC, 4...20 mA	-	M

### Quarter turn actuators with spring return, 24 to 240 VAC/DC, for safe area

Type	Torque	Running time 90°	Spring return	Control mode	Feedback	Features	Size
InMax-30- F	30 Nm	40/60/90/120/150 sec.	~ 20 sec.	On-off, 3-pos	-	-	M
InMax-50- F	50 Nm	40/60/90/120/150 sec.	~ 20 sec.	On-off, 3-pos	-	-	M
InMax-60- F	60 Nm	40/60/90/120 sec.	~ 20 sec.	On-off, 3-pos	-	-	M
InMax-30-SF	30 Nm	40/60/90/120/150 sec.	~ 20 sec.	On-off, 3-pos	2 x aux. switches (5°/85°)	-	M
InMax-50-SF	50 Nm	40/60/90/120/150 sec.	~ 20 sec.	On-off, 3-pos	2 x aux. switches (5°/85°)	-	M
InMax-60-SF	60 Nm	40/60/90/120 sec.	~ 20 sec.	On-off, 3-pos	2 x aux. switches (5°/85°)	-	M
InMax-30-YF	30 Nm	40/60/90/120/150 sec.	~ 20 sec.	3-pos, 0...10 VDC, 4...20 mA	0...10 VDC, 4...20 mA	-	M
InMax-50-YF	50 Nm	40/60/90/120/150 sec.	~ 20 sec.	3-pos, 0...10 VDC, 4...20 mA	0...10 VDC, 4...20 mA	-	M
InMax-30-BF	30 Nm	40/60/90/120/150 sec.	~ 20 sec.	On-off, 3-pos	2 x aux. switches (5°/85°)	InPro-TT-.. connector	M
InMax-50-BF	50 Nm	40/60/90/120/150 sec.	~ 20 sec.	On-off, 3-pos	2 x aux. switches (5°/85°)	InPro-TT-.. connector	M
InMax-60-BF	60 Nm	40/60/90/120 sec.	~ 20 sec.	On-off, 3-pos	2 x aux. switches (5°/85°)	InPro-TT-.. connector	M

### Quarter turn actuators with fast spring return for Offshore application, 24 to 240 VAC/DC, for safe area

Type	Torque	Running time 90°	Spring return*	Control mode	Feedback	Features	Size
InMax-30- F3	30 Nm	40/60/90/120/150 sec.	~ 3 sec.	On-off	-	-	M
InMax-50- F3	50 Nm	40/60/90/120/150 sec.	~ 3 sec.	On-off	-	-	M
InMax-30-SF3	30 Nm	40/60/90/120/150 sec.	~ 3 sec.	On-off	2 x aux. switches (5°/85°)	-	M
InMax-50-SF3	50 Nm	40/60/90/120/150 sec.	~ 3 sec.	On-off	2 x aux. switches (5°/85°)	-	M
InMax-30-BF3	30 Nm	40/60/90/120/150 sec.	~ 3 sec.	On-off	2 x aux. switches (5°/85°)	InPro-TT-.. connector	M
InMax-50-BF3	50 Nm	40/60/90/120/150 sec.	~ 3 sec.	On-off	2 x aux. switches (5°/85°)	InPro-TT-.. connector	M

\*At temperatures below -20 °C, depending on the load, the spring return period can be up to 20 sec. If fast spring return below -20 °C is required, please contact our sales support. Please note that nominal values are also subject to tolerances.

### Accessories

Type	Description/Technical data
InSwitch	External, adaptable, on site adjustable auxiliary switch with 2 potential free contacts, adaptable to InMax-.. actuators
InBox-3P	Terminal box connectable to InMax-.. actuators with 1 cable for On-off or 3-pos operation
InBox-3P/SW	Terminal box connectable to InMax-.. actuators with 1 cable for On-off or 3-pos operation + 2 cable for external aux. switches type InSwitch
InBox-Y/S	Terminal box connectable to InMax-.. actuators with 2 cable, for modulating operation or 3-pos + integrated switches (HS)
InBox-Y/S/SW	Terminal box connectable to InMax-.. actuators with 2 cable, for modulating or 3-pos operation with feedback signal + 2 cable for external aux. switches
InBox-BF	Terminal box connectable to InMax-.. actuators with 1 cable, for all InMax-...-BF
InBox-BF/SW	Terminal box connectable to InMax-.. actuators with 1 cable, for all InMax-...-BF + 2 cable for external aux. switches type InSwitch
MKK-M	Mounting bracket for ..Box-terminal boxes for direct coupling to ..Max-.. actuators size M
HV-MU	Manual override, connectable to actuators size M
AR-16-xx	Squared reduction part from 16 x 16 mm to shafts with 14 mm (type AR-16-14), 12 mm (type AR-16-12)
InPro-TT-...	Safety temperature trigger for fire dampers, switching at 71°/72°C, with 1 m cable, suitable only for InMax-...-BF actuators!
EXC-DS1/VA	Safety temperature sensor for duct mounting, potential free contact, switching at 70°C...160°C (10°C steps)
DWB-M	Angle rotation limiter for mounting on actuator size M
Retrofit-Kit-M	Mechanical adaptation for mounting on ..Max actuators size M, required to replace a previous type NOT30...F3, NOT50...F3 or NOT50..
ADM	Different adaptations for different valves available. Please don't hesitate to ask for technical solution

Special options and offshore kits see page 25

## Introducing InMax – Tunnel actuators size "L" for safe area!

90° Quarter turn actuators for ventilation and smoke dampers ...



FOR SAFE AREA

FAIL SAFE WITH SPRING RETURN

HIGH TORQUE

IP67 ALUMINIUM HOUSING

REVERSIBLE SPRING FUNCTION

INTEGRATED TERMINAL BOX

COMPACT DIMENSIONS



## InMax 90° quarter turn actuators "L" for safe area

Industrial

Features of InMax-.. size L (Subject to change!)

InMax...	Size L	Description	Basics
NOT Explosion proof and only for use in safe area IP67		<p>InMax actuators for motorisation of ventilation and smoke dampers in tunnels. Actuator and mechanical spring module available separately.</p> <p><b>Delivery:</b> 1 actuator with integrated terminal box.</p>	<ul style="list-style-type: none"> <li>• 115/230 V AC power supply</li> <li>• Up to 4 motor running times</li> <li>• 95° angle of rotation (5° pretension)</li> <li>• 100% overload protected</li> <li>• Aluminium housing IP67</li> <li>• -20...+65°C</li> <li>• Squared shaft connection 27 x 27 mm</li> <li>• Dimensions in mm (L x W x H): ~ 687 x ~ 242 x ~ 355 <b>with</b> spring module ~ 483 x ~ 242 x ~ 235 <b>w/o</b> spring module</li> <li>• Total weight: ~ 60 kg (actuator: ~ 38 kg, spring module: ~ 22 kg)</li> </ul>

### Quarter turn actuators with spring return, 115/230 V AC, for safe area

Type	Torque	Motor running time 90°	Spring return	Control mode	Feedback	Size
InMax-L-150-F	150 Nm	15/30/60/120 sec.	~ 10 sec./90°	On-off, 3-pos	-	L
InMax-L-150-SF	150 Nm	15/30/60/120 sec.	~ 10 sec./90°	On-off, 3-pos	2 x SPDT *	L

\* Single Pole Double Throw

## ExMax+ LIN & ExRun – Valve actuators for hazardous locations !

Linear applications for valve control ...

HAZARDOUS LOCATIONS ZONE 1, 2, 21, 22

FAST SPRING RETURN TIME

UNIVERSAL POWER SUPPLY

OFFSHORE/MARINE COATED SOLUTION

EASY INSTALLATION

ROBUST IP66 HOUSING

COMPACT DIMENSIONS



**..Max + LIN, ..Run Electrical drive engineering for valves – Overview**

**Overview ..Max + LIN linear guide unit and ..Run valve actuators**

**Installation areas:**

**ExMax-.. + LIN, ExRun-..** ..... actuators for use in hazardous locations zone 1, 2, 21, 22

**RedMax-.. + LIN, RedRun-..** ..... actuators for use in hazardous locations zone 2, 22

**InMax-.. + LIN, InRun-..** ..... actuators for use in safe area

**Application areas:**

**Ex/Red/InMax + LIN** ..... for globe- or 3-way valves (with safety function)

**Ex/Red/InRun** ..... for globe- or 3-way valves

**The actuator concept offers obvious advantages:**

1. Small dimension, compact, easy installation, highest protection classes, cost effective
2. Universal power supply 24 to 240 Volt AC/DC, selfadjustable
3. With or without spring return (spring return only at ..Max + LIN linear guide unit)
4. Robust aluminium housing, IP66
5. Integrated heater for low temperatures
6. On site adjustable motor running time
7. Integrated manual override
8. Offshore/ marine coated version available
9. Useful accessories such as retrofit limit switches

**N ExMax+LIN**

7,5 mm-  
42 mm

**Actuators with spring return for 2-way and 3-way valves**

normal wiring



**ExMax-.., RedMax-.., InMax-.. + LIN linear guide unit**

Linear motion valve actuators with spring return from 500 to 3.000 N. Fixed stroke with 7.5, 10, 15, 20, 30, or 42 mm, for automation of globe- or 3-way valves. Linkage to numerous valve types and brands available.

**N ExRun**

5 mm-  
60 mm

**Actuators for 2-way and 3-way valves**

normal wiring



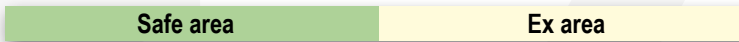

**ExRun-.., RedRun-.., InRun-.. valve actuators**

Valve actuators from 500 to 10.000 N. On site adjustable stroke from 5 to 60 mm, for automation of globe- or 3-way valves. Linkage to numerous valve types and brands available.





**..Max-.. + LIN-.. Linear valve actuators size "S" and "M" with spring return**

Explosion proof		Industrial	Features ..Max-.. + LIN-.. (size S and M)	
<p><b>ExMax-.. + LIN-..</b></p> <p>Zone 1, 2, 21, 22 Gas + Dust certified according to ATEX, IECEx, EAC, INMETRO, KOSHA<sup>1</sup> <sup>1</sup>ExMax size S only UL*, CSA* *...-A version only</p> 	<p><b>RedMax-.. + LIN-..</b></p> <p>Zone 2, 22 Gas + Dust certified according to ATEX, IECEx, EAC, INMETRO, UL*, CSA* *...-A version only</p> 	<p><b>InMax-.. + LIN-..</b></p> <p>NOT Explosion proof and only for use in safe area IP66</p> 	<p><b>Description</b></p> <p>..Max-.. + LIN-.. linear valve actuators with <b>spring return</b> for automation of globe- or 3-way valves. Use as actuator with safety function, On-off or 3-pos. actuator or modulating actuator. <b>Delivery:</b> Linear unit, suitable for all ..Max-..-F actuators size S or M. <b>Required accessories:</b> Valve adaptation in accordance with valve manufacturer, type and nominal size (diameter), terminal box, mounting bracket. <b>Ordering example:</b> Modulating valve actuator with spring return in Ex area zone 2, for a globe valve with 20 mm stroke and a required force of 1.500 N.</p> <p>Actuator: RedMax-30-YF Linear adaptation: LIN-20 Valve adaptation: suitable for valve type on requ. Required: Ex terminal box (RedBox-Y/S) Required: Mounting bracket (MKK-M)</p>	<p><b>Basics</b></p> <ul style="list-style-type: none"> <li>• 24...240 VAC/DC self adaptable power supply</li> <li>• Running time 0,1...15 sec./mm<sup>1</sup></li> <li>• Stroke 7,5, 10, 15, 20, 30, 42 mm<sup>1</sup></li> <li>• Force 500...3.000 N<sup>1</sup></li> <li>• Spring return 3/10 sec. (size S), 20 sec. (size M)<sup>1</sup></li> <li>• Control mode On-off, 3-pos., 0-10 VDC, 4-20 mA<sup>1</sup></li> <li>• Aluminium housing, IP66<sup>2</sup></li> <li>• Ambient temperature -20...+40 °C (T6), -20...+50 °C (T5)</li> <li>• Weight (incl. actuator) ~ 8 kg (size S), ~ 14 kg (size M)<sup>1</sup></li> <li>• External terminal box optional<sup>2</sup></li> </ul> <p><sup>1</sup> in acc. with type   <sup>2</sup> applies for actuator</p>

**Linear unit for actuators with spring return, 24 to 240 VAC/DC**

Type	Stroke (max.)	Description
LIN-7.5	7,5 mm	Linear unit up to max. 7,5 mm stroke, suitable for all ..Max-...-F actuators size S or M with spring return
LIN-10	10 mm	Linear unit up to max. 10 mm stroke, suitable for all ..Max-...-F actuators size S or M with spring return
LIN-15	15 mm	Linear unit up to max. 15 mm stroke, suitable for all ..Max-...-F actuators size S or M with spring return
LIN-20	20 mm	Linear unit up to max. 20 mm stroke, suitable for all ..Max-...-F actuators size S or M with spring return
LIN-30	30 mm	Linear unit up to max. 30 mm stroke, suitable for all ..Max-...-F actuators size S or M with spring return
LIN-40	42 mm	Linear unit up to max. 42 mm stroke, suitable for all ..Max-...-F actuators size M with spring return

Additional price for adaptation, dependent on valve manufacturer, valve type and stroke.

**LIN Special options for linear unit suitable for actuators**

Explosion proof/Safe area	Features LIN-...-CT		
<p><b>LIN-...CT</b></p> <p>available for linear unit LIN-.. In accordance with ..Max type for use in Ex area or safe area</p>	<p><b>Special options</b></p> 	<p><b>Description</b></p> <p>CT version with aluminium housing and offshore/marine coating, resistant against corrosive and maritime atmosphere, some parts nickel plated.</p> <p><b>Delivery:</b> 1 linear unit with special option <b>Ordering example:</b> LIN-20-CT</p>	<p><b>Basics</b></p> <p><b>CT:</b></p> <ul style="list-style-type: none"> <li>• Offshore/marine coated aluminium housing</li> <li>• Resistant against corrosive and/or maritime atmosphere</li> </ul>

**LIN-.. options**

Type	Description/Technical data
LIN-...-CT	Offshore/marine coated aluminium housing, resistant against corrosive and/or maritime atmosphere. Lifting rod, connecting parts and screws in VA (surcharge)
ADLIN	Different adaptations for different valves available. Please don't hesitate to ask for technical solution

Additional price for adaptation in stainless steel (VA) for CT version.

Mounting variations

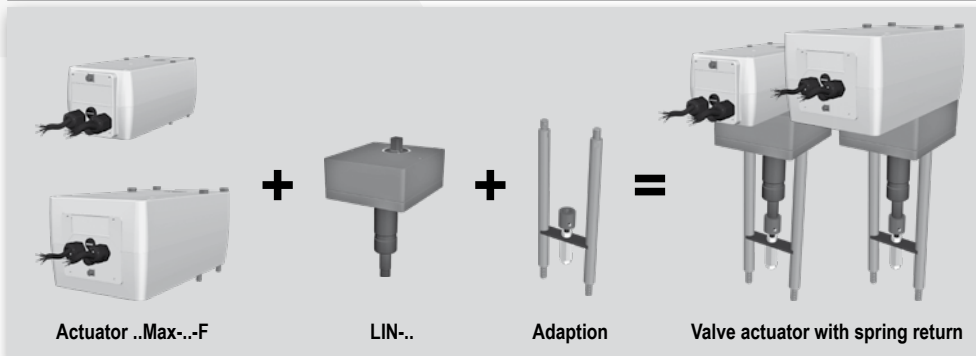

Valve adaptation

To select the right valve adaptation and get the right price information the following data are required:

1. Valve manufacturer
2. Valve type
3. Valve nominal size (diameter) DN

For adaptations which are already designed by Schischek this information is sufficient.

To design new adaptations we need additional details of the valve body as well as drawings.

With the purchase order you have to provide actuator and valve type.

Selection of recommended actuators in relation of force and max. stroke

Type max. stroke	LIN - 7.5	LIN - 10	LIN - 15	LIN - 20	LIN - 30	LIN - 40	
Force	7.5 mm	10 mm	15 mm	20 mm	30 mm	42 mm	
500 N	...Max- 15 - ...F	...Max- 15 - ...F	...Max- 15 - ...F	...Max- 15 - ...F	...Max- 15 - ...F	...Max- 30 - ...F	At strokes between two values use the next higher linear unit e.g. 24 mm stroke = LIN-30
800 N				...Max- 30 - ...F	...Max- 30 - ...F		
1.000 N			...Max- 30 - ...F	...Max- 50 - ...F	...		
1.500 N			...Max- 50 - ...F	...	...		
2.000 N	...	...	...	...	...		
2.500 N	...Max- 30 - ...F	...Max- 30 - ...F	...Max- 50 - ...F	...Max- 50 - ...F	...	...	
3.000 N	...	...	...	...	...	...	

**Attention:** Limitation of resolution at YF-actuators with strokes < nominal (motor blockade)!  
Note the maximum force of the actuator to prevent damage to your valve!

**Info:** Suitable actuators with spring return see page 10-15.

1

Nominal force (N) at spring of actuator in relation of max. stroke of LIN at temperatures between -20...+40 °C

Nominal force (N)	LIN - 7.5	LIN - 10	LIN - 15	LIN - 20	LIN - 30	LIN - 40	
...Max- 15 -F	1,500	1,500	1,000	800	500	-	Blocking force in motor is round about 3 to 4 times larger than nominal force. <b>Note valve dimensioning!</b>
...Max- 30 -F	3,000	3,000	2,000	1,500	1,000	800	
...Max- 50 -F	-	-	3,000	3,000	2,000	1,500	

**Attention:** Limitation of resolution at YF-actuators with strokes < nominal (motor blockade)!  
Note the maximum force of the actuator to prevent damage to your valve!

2

Blocking force (N) at spring of actuator in relation of max. stroke of LIN at temperatures between 0...+40 °C



Nominal force (N)	LIN - 7.5	LIN - 10	LIN - 15	LIN - 20	LIN - 30	LIN - 40	
...Max- 15 -F	3,000	3,000	2,000	1,600	1,000	-	Blocking force in motor is round about 1.5 to 2 times larger than nominal force. <b>Note valve dimensioning!</b>
...Max- 30 -F	6,000	6,000	4,000	3,000	2,000	1,600	
...Max- 50 -F	-	-	6,000	6,000	4,000	3,000	

**Attention:** Above mentioned values are nominal trusts with performed self adjustment drive!

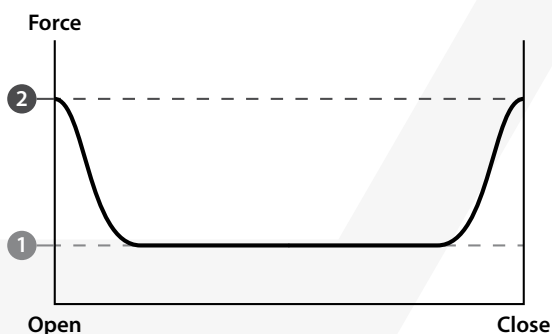
The maximum trusts can read values which are up to three to four times higher than values of tables!  
Without performed self adjustment drive there can occur much higher trust values, which can cause damages on the mentioned valve or linkages!  
Spring return time depends on the effective required thrust and can exceed standard values!



## ExRun/RedRun/InRun Valve actuators

Explosion proof		Industrial	Features of ExRun-..., RedRun-..., InRun-...	
<b>ExRun-..</b> Zone 1, 2, 21, 22 Gas + Dust certified according to ATEX, IECEx, EAC, INMETRO, KOSHA, UL*, CSA* *...-A version only	<b>RedRun-..</b> Zone 2, 22 Gas + Dust certified according to ATEX, IECEx, EAC, INMETRO, KOSHA, UL*, CSA* *...-A version only	<b>InRun-..</b> NOT Explosion proof and only for use in safe area IP66	<b>Description</b> ExRun-..., RedRun-... and InRun-... valve actuators are used for automation of 2- and 3-way valves with 3-pos. on-off or modulating mode.	<b>Basics</b> <ul style="list-style-type: none"> <li>• 24...240 VAC/DC self adaptable power supply</li> <li>• Up to 5 different running times adjustable on site</li> <li>• 5 to 60 mm stroke, mechanical limitation on each position</li> <li>• Automatic adaptation of modulating signal at Ex-, Red-, InRun-...-Y...</li> <li>• Aluminium housing IP66, integrated terminal box</li> <li>• -20...+40°C/+50°C, integrated heater</li> <li>• Emergency manual override</li> <li>• Dimension (H<sup>1</sup>×W×D) 260<sup>1</sup> × 208 × 115 mm (without valve and adaptation)</li> <li>• Approximate weight 7,3...7,7 kg<sup>2</sup> (without valve and adaptation)</li> </ul> <sup>1</sup> Height varies depending on type <sup>2</sup> Weight varies depending on type
<b>Delivery:</b> 1 actuator with integrated Ex-e terminal box, Emergency manual override.			<b>Required accessories:</b> Valve adaptation in accordance with valve manufacturer, type and nominal size (diameter).	
				

### Ex-d valve actuators without spring return for zone 1, 2, 21, 22

Type	Force	Running time	Spring return	Control mode	Feedback	Stroke	Size
ExRun- 5.10	500 / 1.000 N	2/3/6/9/12 sec/mm	-	On-off, 3-pos	-	5...60 mm	S
ExRun-25.50	2.500 / 5.000 N	2/3/6/9/12 sec/mm	-	On-off, 3-pos	-	5...60 mm	S
ExRun-75.100	7.500 / 10.000 N	4/6/9/12/15 sec/mm	-	On-off, 3-pos	-	5...60 mm	S
ExRun- 5.10 -Y	500 / 1.000 N	2/3/6/9/12 sec/mm	-	0...10 VDC, 4...20 mA	0...10 VDC, 4...20 mA	5...60 mm	S
ExRun-25.50 -Y	2.500 / 5.000 N	2/3/6/9/12 sec/mm	-	0...10 VDC, 4...20 mA	0...10 VDC, 4...20 mA	5...60 mm	S
ExRun-75.100-Y	7.500 / 10.000 N	4/6/9/12/15 sec/mm	-	0...10 VDC, 4...20 mA	0...10 VDC, 4...20 mA	5...60 mm	S
ExRun- 5.10 -U	500 / 1.000 N	2/3/6/9/12 sec/mm	-	On-off, 3-pos	0...10 VDC, 4...20 mA	5...60 mm	S
ExRun-25.50 -U	2.500 / 5.000 N	2/3/6/9/12 sec/mm	-	On-off, 3-pos	0...10 VDC, 4...20 mA	5...60 mm	S
ExRun-75.100-U	7.500 / 10.000 N	4/6/9/12/15 sec/mm	-	On-off, 3-pos	0...10 VDC, 4...20 mA	5...60 mm	S

### Ex-d valve actuators without spring return for zone 2, 22

Type	Force	Running time	Spring return	Control mode	Feedback	Stroke	Size
RedRun- 5.10	500 / 1.000 N	2/3/6/9/12 sec/mm	-	On-off, 3-pos	-	5...60 mm	S
RedRun-25.50	2.500 / 5.000 N	2/3/6/9/12 sec/mm	-	On-off, 3-pos	-	5...60 mm	S
RedRun-75.100	7.500 / 10.000 N	4/6/9/12/15 sec/mm	-	On-off, 3-pos	-	5...60 mm	S
RedRun- 5.10 -Y	500 / 1.000 N	2/3/6/9/12 sec/mm	-	0...10 VDC, 4...20 mA	0...10 VDC, 4...20 mA	5...60 mm	S
RedRun-25.50 -Y	2.500 / 5.000 N	2/3/6/9/12 sec/mm	-	0...10 VDC, 4...20 mA	0...10 VDC, 4...20 mA	5...60 mm	S
RedRun-75.100-Y	7.500 / 10.000 N	4/6/9/12/15 sec/mm	-	0...10 VDC, 4...20 mA	0...10 VDC, 4...20 mA	5...60 mm	S
RedRun- 5.10 -U	500 / 1.000 N	2/3/6/9/12 sec/mm	-	On-off, 3-pos	0...10 VDC, 4...20 mA	5...60 mm	S
RedRun-25.50 -U	2.500 / 5.000 N	2/3/6/9/12 sec/mm	-	On-off, 3-pos	0...10 VDC, 4...20 mA	5...60 mm	S
RedRun-75.100-U	7.500 / 10.000 N	4/6/9/12/15 sec/mm	-	On-off, 3-pos	0...10 VDC, 4...20 mA	5...60 mm	S

### Valve actuators without spring return for safe area

Type	Force	Running time	Spring return	Control mode	Feedback	Stroke	Size
InRun- 5.10	500 / 1.000 N	2/3/6/9/12 sec/mm	-	On-off, 3-pos	-	5...60 mm	S
InRun-25.50	2.500 / 5.000 N	2/3/6/9/12 sec/mm	-	On-off, 3-pos	-	5...60 mm	S
InRun-75.100	7.500 / 10.000 N	4/6/9/12/15 sec/mm	-	On-off, 3-pos	-	5...60 mm	S
InRun- 5.10 -Y	500 / 1.000 N	2/3/6/9/12 sec/mm	-	0...10 VDC, 4...20 mA	0...10 VDC, 4...20 mA	5...60 mm	S
InRun-25.50 -Y	2.500 / 5.000 N	2/3/6/9/12 sec/mm	-	0...10 VDC, 4...20 mA	0...10 VDC, 4...20 mA	5...60 mm	S
InRun-75.100-Y	7.500 / 10.000 N	4/6/9/12/15 sec/mm	-	0...10 VDC, 4...20 mA	0...10 VDC, 4...20 mA	5...60 mm	S
InRun- 5.10 -U	500 / 1.000 N	2/3/6/9/12 sec/mm	-	On-off, 3-pos	0...10 VDC, 4...20 mA	5...60 mm	S
InRun-25.50 -U	2.500 / 5.000 N	2/3/6/9/12 sec/mm	-	On-off, 3-pos	0...10 VDC, 4...20 mA	5...60 mm	S
InRun-75.100-U	7.500 / 10.000 N	4/6/9/12/15 sec/mm	-	On-off, 3-pos	0...10 VDC, 4...20 mA	5...60 mm	S

**Accessories**

Type	Description/Technical data
<b>ExSwitch-R-L</b>	External, adaptable, on site adjustable Ex-d auxiliary switch linear for Ex/RedRun... with 2 potential free contacts, additionally Ex-e terminal box + mounting bracket necessary
<b>InSwitch- R-L</b>	External, adaptable, on site adjustable auxiliary switch linear for InRun... with 2 potential free contacts, additionally terminal box + mounting bracket necessary
<b>ExBox- SW</b>	Ex-e terminal box suitable for ExRun.. valve-actuators with external switches ExSwitch-R-L
<b>RedBox-SW</b>	Ex-e terminal box suitable for RedRun.. valve-actuators with external switches ExSwitch-R-L
<b>InBox- SW</b>	Terminal box suitable for InRun.. valve-actuators with external switches InSwitch-R-L
<b>MKK-S</b>	Mounting-bracket suitable for ..Box-terminal boxes for direct mounting on ..Run actuators size S
<b>HV-R</b>	Manual override suitable for ..Run valve actuators size S
<b>GMB-1</b>	Rubber bellow up to 60 mm, colour black
<b>ADR</b>	Different adaptations for different valves available. Please don't hesitate to ask for technical solution

Special options and offshore kits see page 25

**Required data for valve adaptation**

To select the right valve adaptation and get the right price information the following data are required:

- 1. Valve manufacturer**
- 2. Valve type**
- 3. Valve nominal size (diameter) DN**

For adaptations which are already designed by Schischek this information is sufficient.

To design new adaptations we need additional details of the valve body as well as drawings.

With the purchase order you have to provide actuator and valve type.

**...Run + valve adaptation**

ExRun...

RedRun...

InRun...



Adaption





## VA/CT Special options actuators – overview



Overview of special options of Schischek actuators for use under extreme weather conditions

**Application area:**

Usage in hazardous locations under extreme weather conditions and/or for offshore/onshore applications.

**Advantages:**

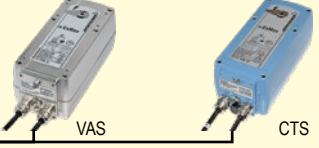
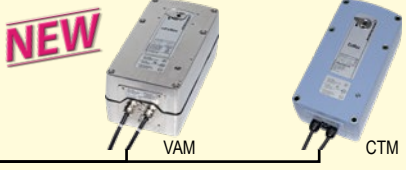
- Resistant against corrosive and/or maritime atmosphere
- Usage under extreme weather conditions
- Approved for offshore-/onshore applications
- Robust and thereby extended period of application time of actuators

		Special options quarter turn actuators size S			
VAS CTS	..Max.. S	normal wiring			<p><b>..Max.. ¼ turn actuators size S</b></p> <p>Housing material in stainless steel (VAS) or aluminium housing with offshore/marine coating (CTS) for use under extreme weather conditions.</p>
VAM CTM	..Max.. M	normal wiring			<p><b>..Max.. ¼ turn actuators size M</b></p> <p>Housing material in stainless steel (VAM) or aluminium housing with offshore/marine coating (CTM) for use under extreme weather conditions.</p>
CTS	..Run..	normal wiring			<p><b>..Run.. valve actuators</b></p> <p>Aluminium housing with offshore/marine coating (CTS) for use under extreme weather conditions.</p>
WS-S WS-M WS-R	..Max.. S/M ..Run..	normal wiring			<p><b>..Max.. ¼ turn and ..Run valve actuators</b></p> <p>Weather shield made of stainless steel for protection against weather influences like rain, sun or snow.</p>

**Safe area** | **Ex area**

- Further special features on request**
- Connection technology and cable fittings
  - Special model for temperature range, runtime, corrosion protection, certification, ...
  - Special accessories, for e.g. indicators
  - Special features, e.g. > 90° angle of rotation or rotary variants

**..Max Special options for quarter turn actuators size S or M**

Explosion proof

Features ..Max-...VA/CT

**..Max-...VA/CT**

available for ExMax, RedMax and InMax  
In accordance with type for use in Ex area or safe area

Special options



Description

VA version with housing material in stainless steel similar AISI 316, some parts nickel plated.  
CT version with aluminium housing and offshore/marine coating, resistant against corrosive and maritime atmosphere, some parts nickel plated.

**Delivery:** 1 quarter turn actuator size S or M with special option  
**Ordering example:** ExMax-15.30-VAS

Basics

**VA:**  
• Housing material in stainless steel similar AISI 316, some parts nickel plated, screws in stainless steel

**CT:**  
• offshore/marine coated aluminium housing, resistant against corrosive and/or maritime atmosphere  
• Cable glands brass nickel plated  
• Screws in stainless steel

**For general basics see ..Max quarter turn actuators.**

**..Max-.. options**

**NEW**

Type	Description/Technical data
..Max-... VAS	Housing material of ..Max quarter turn actuator size S in stainless steel similar AISI 316, some parts nickel plated (surcharge)
..Max-... VAM	Housing material of ..Max quarter turn actuator size M in stainless steel similar AISI 316, some parts nickel plated (surcharge)
..Max-... CTS	Aluminium housing of ..Max quarter turn actuator size S with offshore/marine coating, resistant against corrosive and maritime atmosphere, some parts nickel plated (surcharge)
..Max-... CTM	Aluminium housing of ..Max quarter turn actuator size M with offshore/marine coating, resistant against corrosive and maritime atmosphere, some parts nickel plated (surcharge)
..Box-.../ VA	Ex-e terminal-box, housing made of stainless-steel type AISI 316 L, some parts nickel plated (surcharge)
..Box-.../ CT	Ex-e terminal-box, housing offshore/marine coated, resistant against corrosive/maritime atmosphere, some parts nickel plated (surcharge)
..Switch- CT	Auxiliary switch for ..Max-..., housing offshore/marine coated, resistant against corrosive/maritime atmosphere, some parts nickel plated (surcharge)
MKK- S/VA	Mounting bracket, made of stainless-steel suitable for ..Box...VA for direct coupling to ..Max actuators size S
MKK- M/VA	Mounting bracket, made of stainless-steel suitable for ..Box...VA for direct coupling to ..Max actuators size M
Kit-S8-Max	Cable glands 2 x M16 x 1,5 mm Ex-e standard Ø 5-10 mm in brass nickel plated, 1 blind plug for replace the plastic version of quarter turn actuator ..Max
Kit-S8-Box	Cable glands 4 x M20 x 1,5 mm Ex-e Ø 6-13 mm, brass nickel plated, for replace the plastic version of terminal ..Box
Kit-Offs-PMC-1C	Protection metal conduit incl. SS terminal box and glands for 1 armoured cable
Kit-Offs-PMC-2C	Protection metal conduit incl. SS terminal box and glands for 2 armoured cables
WS-S	Weather shield in stainless steel, suitable for all ..Max actuators size S
WS-M	Weather shield in stainless steel, suitable for all ..Max actuators size M

**..Run Special options for valve actuators**

Explosion proof

Features ..Run-...CTS

**..Run-...CTS**

available for ExRun, RedRun and InRun  
In accordance with type for use in Ex area or safe area

Special options



Description

CTS version with aluminium housing and offshore/marine coating, resistant against corrosive and maritime atmosphere, some parts nickel plated.

**Delivery:** 1 valve actuator with special option  
**Ordering example:** ExRun-25.50-CTS

Basics

**CTS:**  
• offshore/marine coated aluminium housing, resistant against corrosive and/or maritime atmosphere  
• Cable glands brass nickel plated  
• Screws in stainless steel

**For general basics see ..Run valve actuators.**

**..Run-.. options**

Type	Description/Technical data
..Run-...-CTS	Aluminium housing with offshore/marine coating for ..Run valve actuator, resistant against corrosive/maritime atmosphere, some parts nickel plated (surcharge)
Kit-S8- Run	Cable glands 2 x M20 x 1,5 mm Ex-e Ø 6-13 mm, brass nickel plated, for replace the plastic version of valve actuators ..Run
Kit-Offs-GL-Run	Cable glands 2 x M25 x 1,5 mm Ex-d in brass nickel plated for armoured cables suitable for ..Run valve actuators
WS-R	Weather shield in stainless steel, suitable for all ..Run valve actuators

## ExPolar/InPolar Heating system – overview

Overview of new heating system for use with Schischek actuators down to  $-50^{\circ}\text{C}$

**Application area:**

Usage in hazardous locations for temperatures down to  $-50^{\circ}\text{C}$ .

**Advantages:**

- Especially for usage under high sub-zero temperatures down to  $-50^{\circ}\text{C}$
- Usage directly in hazardous locations (only ExPolar)
- Adaptable on Schischek actuator series type ..Max size S or M

$^{\circ}\text{C}$  ExPolar-..MS



Heating system for quarter turn actuators ExMax size S

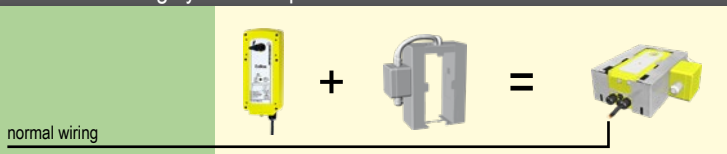

**ExPolar-..MS**

Adaptable on Schischek quarter turn actuators type ExMax-.. size S.

$^{\circ}\text{C}$  ExPolar-..MM



Heating system for quarter turn actuators ExMax size M

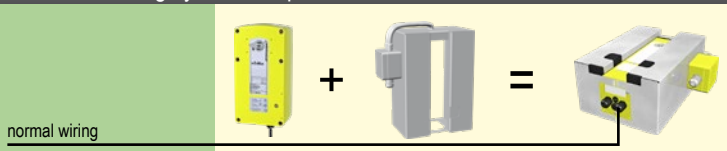



**ExPolar-..MM**

Adaptable on Schischek quarter turn actuators type ExMax-.. size M.

Safe area

Ex area

### ExPolar/InPolar Heating system for ¼ turn actuators ..Max-.. size S

Explosion proof	Industrial	Features ..Polar-...-MS	
<b>ExPolar-...-MS</b> Hazardous Location 	<b>InPolar-...-MS</b> Safe Area 	<b>Description</b> Controlled heating system for use in sub-zero regions down to -50 °C. Adaptable on Schischek quarter turn actuators ..Max-.. size S (depending on type).  <b>Delivery:</b> 1 heating system (adaptable) <b>Ordering example:</b> ExPolar-240-MS	<b>Basics</b> <ul style="list-style-type: none"> <li>• 24/48 VAC/DC; 120/240 VAC</li> <li>• 60 W</li> <li>• -50 °C... +60 °C</li> <li>• ExPolar for zone 1, 2, 21, 22</li> <li>• InPolar for safe area</li> </ul>

### ExPolar-...-MS/InPolar-...-MS



Type	Adaptable on	Operation temperature	Supply	Power*	Installation area
ExPolar-...-MS	ExMax-../RedMax size S	-50 °C up to +60 °C	24 VAC/DC 48 VAC/DC 120 VAC 240 VAC	60 W	zone 1, 2, 21, 22
InPolar-...-MS	InMax-.. size S	-50 °C up to +60 °C	24 VAC/DC 48 VAC/DC 120 VAC 240 VAC	60 W	safe area

↑ Supply voltage

Not suitable for VA versions!

\*Nominal value

### ExPolar/InPolar Heating system for ¼ turn actuators ..Max-.. size M

Explosion proof	Industrial	Features ..Polar-...-MM	
<b>ExPolar-...-MM</b> Hazardous Location 	<b>InPolar-...-MM</b> Safe Area 	<b>Description</b> Controlled heating system for use in sub-zero regions down to -50 °C. Adaptable on Schischek quarter turn actuators ..Max-.. size M (depending on type).  <b>Delivery:</b> 1 heating system (adaptable) <b>Ordering example:</b> ExPolar-240-MM	<b>Basics</b> <ul style="list-style-type: none"> <li>• 24/48 VAC/DC; 120/240 VAC</li> <li>• 60 W</li> <li>• -50 °C... +60 °C</li> <li>• ExPolar for zone 1, 2, 21, 22</li> <li>• InPolar for safe area</li> </ul>

### ExPolar-...-MM/InPolar-...-MM

Type	Adaptable on	Operation temperature	Supply	Power*	Installation area
ExPolar-...-MM	ExMax-../RedMax size M	-50 °C up to +60 °C	24 VAC/DC 48 VAC/DC 120 VAC 240 VAC	60 W	zone 1, 2, 21, 22
InPolar-...-MM	InMax-.. size M	-50 °C up to +60 °C	24 VAC/DC 48 VAC/DC 120 VAC 240 VAC	60 W	safe area

↑ Supply voltage

Not suitable for VA versions!

\*Nominal value

### Special option

Type	Description/Technical data
...Polar-...-CT	Housing offshore/marine coated, resistant against corrosive/maritime atmosphere, some parts nickel plated (surcharge)

### ExArctic/InArctic Heating system for actuators ..Max/..Run/..Max+LIN

**NEW**

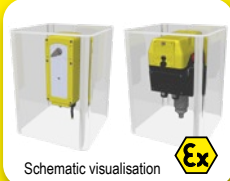
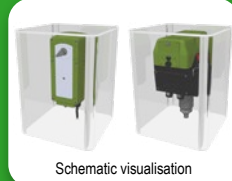
Explosion proof	Industrial	Features ..Arctic-..	
<b>ExArctic-M   ExArctic-R</b> Hazardous Location 	<b>InArctic-M   InArctic-R</b> Safe Area 	<b>Description</b> Controlled heating system with protective housing for use down to -60 °C. Suitable for Schischek actuators ..Max size S and M as well as for valve actuators ..Run / ..Max + LIN.  <b>Delivery:</b> 1 heating system 1 protective housing 1 mounting material set	<b>Basics</b> <ul style="list-style-type: none"> <li>• -60 °C</li> <li>• ExArctic for hazardous locations</li> <li>• InArctic for safe area</li> <li>• details and prices on request</li> <li>• subject to change</li> </ul>



## ExReg – HVAC control unit for hazardous locations!

Control applications for VAV/CAV, pressure, temperature and humidity ...



HAZARDOUS LOCATIONS ZONE 1, 2, 21, 22

DECENTRALISED CONTROL STRUCTURES

REDUCED LIFE-CYCLE-COSTS

NO INTRINSIC SAFE CIRCUITS NEEDED

INTEGRAL PID LOOP

COMPATIBILITY TO MARKET STANDARDS

PREDEFINED SETTINGS

PREDEFINED DAMPER CHARACTERISTICS

## ExReg-../InReg-.. Control systems – overview

### Overview of the new ExReg-.. and InReg-.. control systems solution

**Installation areas:**

ExReg-.....Modules for use in hazardous locations zone 1, 2, 21, 22  
InReg-.....Modules for safe area

**Application areas:**

ExReg/InReg-V.....Modules for volume flow control (CAV/VAV)  
ExReg/InReg-V.....Modules for differential pressure control (ΔP)  
ExReg/InReg-D.....Modules for temperature control  
ExReg/InReg-D.....Modules for humidity control

**The new control systems concept offers especially in Ex-area huge benefits:**

1. Usage directly in hazardous locations in zone 1, 2, 21, 22
2. Can be configured on site in the hazardous location
3. Decentralised control structures
4. Fewer components
5. Reduced Life-Cycle-Costs
6. No necessity to install safety barriers or to use special wiring
7. Integral PID loop
8. Optional in stainless steel (AISI 316) or with offshore/marine coating
9. Predefined Settings and damper characteristics
10. Cost effective

VAV  
ΔP

ExReg-V

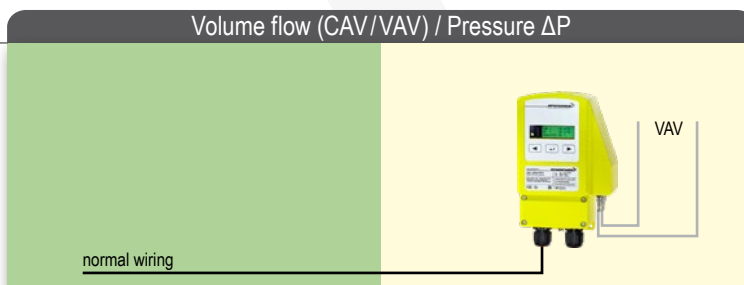

**ExReg-V-.., InReg-V-..**

Control of air flows and pressure in ventilation systems for building management control equipment, for chemical, pharmaceutical, industrial and offshore plants directly in hazardous locations zones 1, 2 (gas) and 21, 22 (dust), (InReg-V-.. in safe area). To complete the technical solution on a ventilation damper (with orifice plate and known shield/k-factor) an additional actuator type ExMax-...-CY or ExMax-...-CYF (with fail safe spring return) is required.

°C

ExReg-D

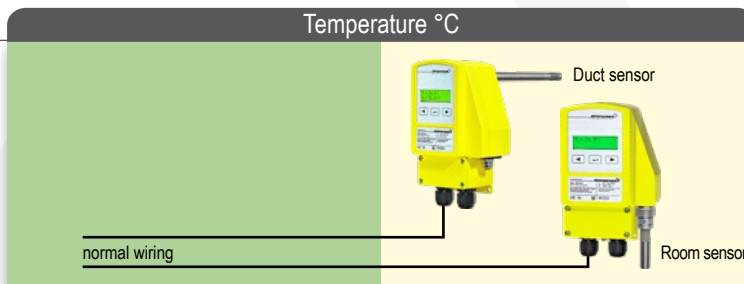

**ExReg-D-.., InReg-D-..**

Control of temperature in ventilation systems for building management control equipment, for chemical, pharmaceutical, industrial and offshore plants directly in hazardous locations zones 1, 2 (gas) and 21, 22 (dust), (InReg-D-.. in safe area). To complete the technical solution an additional valve actuator type ExMax-...-CY, ExMax-...-CYF (with fail safe spring return) or ExRun-.. is required.

%rH

ExReg-D

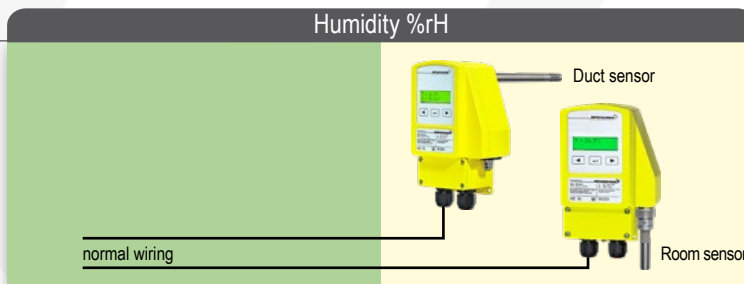

**ExReg-D-.., InReg-D-..**

Control of humidity in ventilation systems for building management control equipment, for chemical, pharmaceutical, industrial and offshore plants directly in hazardous locations zones 1, 2 (gas) and 21, 22 (dust), (InReg-D-.. in safe area). To complete the technical solution an additional valve actuator type ExMax-...-CY, ExMax-...-CYF (with fail safe spring return) or ExRun-.. is required.

Safe area

Ex area

**ExReg-V../InReg-V.. Volume flow and pressure controller CAV/VAV**

VAV applications in a typical HVAC system

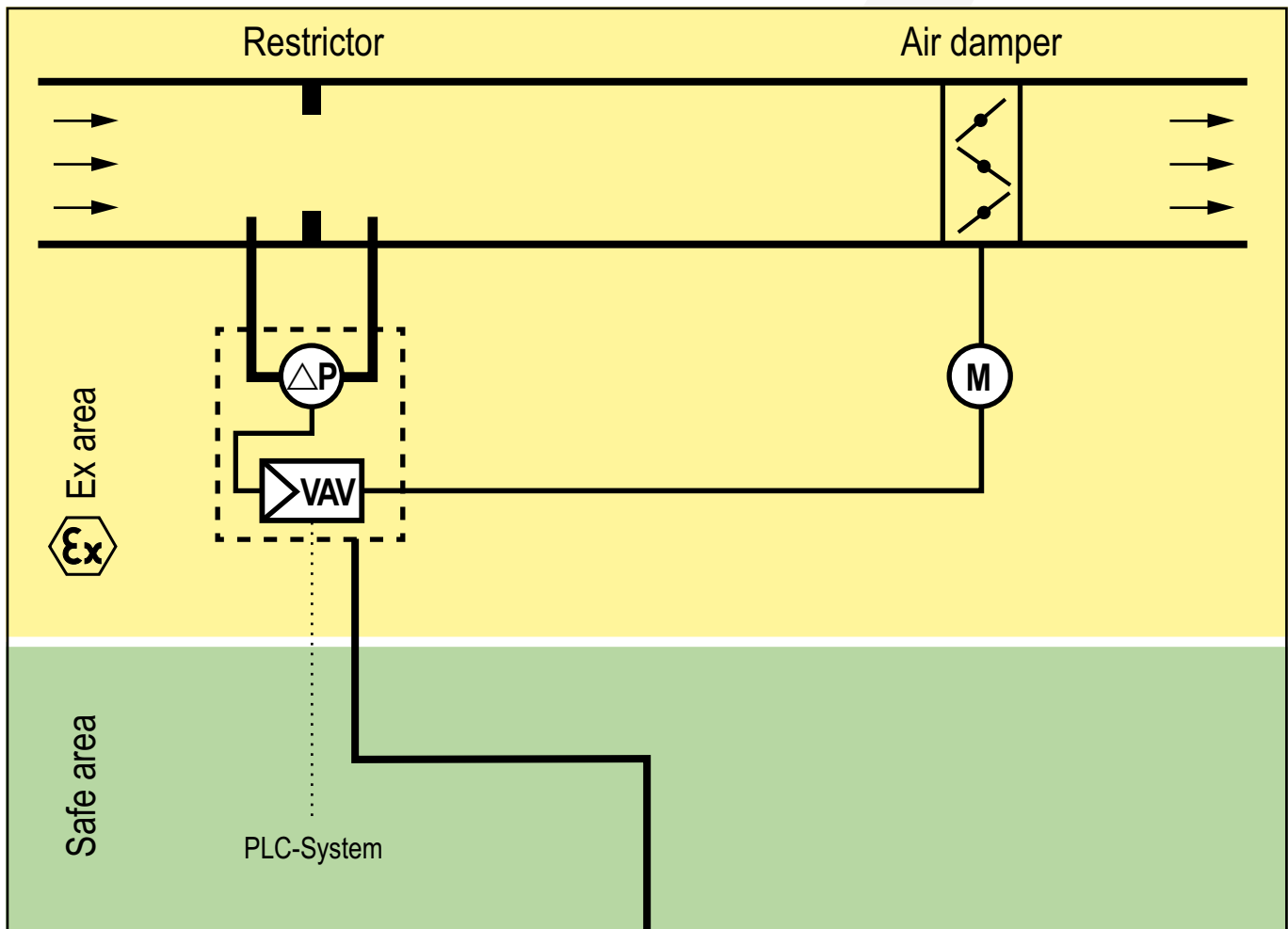



**Controller**

**ExReg-V..**  
**Differential pressure**

- 0... 100/300/1.000 Pa, depending on type (VAV)



## ExReg-V../InReg-V.. Volume flow and pressure controller CAV/VAV

Explosion proof	Industrial	Features of ExReg-V.., InReg-V..	
<p><b>ExReg-V..</b></p> <p>Zone 1, 2, 21, 22 Gas + Dust certified according to ATEX, IECEx</p> 	<p><b>InReg-V..</b></p> <p>NOT explosion proof and only for use in safe area IP66</p> 	<p><b>Description</b></p> <p>Compact controller for use in hazardous areas zone 1, 2, 21, 22 or in safe area (depending on type) for control/regulation of air/gas flows and pressure in ventilation systems. VAV control must be tested by the manufacturer of VAV dampers in acc. with diameter, design and characteristics of the air damper! Suitable actuator ..Max-...-CY or ..Max-...-CYF available separately.</p> <p><b>Delivery:</b> Electric volume flow/pressure controller with integrated terminal box (ExReg.. with "Ex-e"), 3 tapping screws, short circuit tube</p>	<p><b>Basics</b></p> <ul style="list-style-type: none"> <li>• No additional module in the panel required</li> <li>• No intrinsically safe wiring required</li> <li>• Adjustable "k-factor"</li> <li>• Measurement range 0...100/300/1.000 Pa</li> <li>• 24 VAC/DC</li> <li>• Switch-on delay 3 seconds</li> <li>• Air volume monitoring</li> <li>• PID controller</li> <li>• Programmable w/o additional tools</li> <li>• Alarm with alarm delay function</li> <li>• LCD backlight (which can be switched off)</li> <li>• Aluminium housing, protection IP66</li> <li>• Integrated terminal box (ExReg.. with "Ex-e")</li> <li>• Optional offshore/marine coated or stainless steel edition</li> <li>• H x W x D = 180 x 107 x 66 mm</li> </ul>

### ExReg-V.. Volume flow and pressure controller for zone 1, 2, 21, 22

Type	Sensor	Supply	Meas. range	Connection/Interface (analogue)	Installation
ExReg-V100-A	Differential pressure	24 VAC/DC	0...100 Pa	1 x actuator, 1 x set point, 1 x actual value, 1 x position actuator	zone 1, 2, 21, 22
ExReg-V300-A	Differential pressure	24 VAC/DC	0...300 Pa	1 x actuator, 1 x set point, 1 x actual value, 1 x position actuator	zone 1, 2, 21, 22
ExReg-V1000-A	Differential pressure	24 VAC/DC	0...1.000 Pa	1 x actuator, 1 x set point, 1 x actual value, 1 x position actuator	zone 1, 2, 21, 22

### InReg-V.. Volume flow and pressure controller for safe area

Type	Sensor	Supply	Meas. range	Connection/Interface (analogue)	Installation
InReg-V100-A	Differential pressure	24 VAC/DC	0...100 Pa	1 x actuator, 1 x set point, 1 x actual value, 1 x position actuator	safe area
InReg-V300-A	Differential pressure	24 VAC/DC	0...300 Pa	1 x actuator, 1 x set point, 1 x actual value, 1 x position actuator	safe area
InReg-V1000-A	Differential pressure	24 VAC/DC	0...1.000 Pa	1 x actuator, 1 x set point, 1 x actual value, 1 x position actuator	safe area

### Actuators for ..Reg.. controller

Type	Torque	Running time 90°	Spring return	Control mode	Feedback	Features	Size
ExMax- 5.10-CY	5 Nm / 10 Nm	7,5/15/30/60/120 sec.	-	4...20 mA	0...10 V	combination with ExReg..	S
ExMax-15.30-CY	15 Nm / 30 Nm	7,5/15/30/60/120 sec.	-	4...20 mA	0...10 V	combination with ExReg..	S
ExMax- 5.10-CYF	5 Nm / 10 Nm	7,5/15/30/60/120 sec.	~ 10 sec.	4...20 mA	0...10 V	combination with ExReg..	S
ExMax-15- CYF	15 Nm	7,5/15/30/60/120 sec.	~ 10 sec.	4...20 mA	0...10 V	combination with ExReg..	S
InMax- 5.10-CY	5 Nm / 10 Nm	7,5/15/30/60/120 sec.	-	4...20 mA	0...10 V	combination with InReg..	S
InMax- 15.30-CY	15 Nm / 30 Nm	7,5/15/30/60/120 sec.	-	4...20 mA	0...10 V	combination with InReg..	S
InMax- 5.10-CYF	5 Nm / 10 Nm	7,5/15/30/60/120 sec.	~ 10 sec.	4...20 mA	0...10 V	combination with InReg..	S
InMax- 15- CYF	15 Nm	7,5/15/30/60/120 sec.	~ 10 sec.	4...20 mA	0...10 V	combination with InReg..	S

### Accessories

Type	Description/Technical data
MKR-VA/AL	Mounting bracket for installation on round air-ducts (diameter up to 600 mm)
Kit 2	Includes 2 meter pressure hose (inner diameter 6 mm) and 2 plastic fittings

Special options and offshore kits see page 52



**ExReg-D-../InReg-D-.. Temperature °C/humidity %rH controller**

Temperature and humidity applications in a typical HVAC system

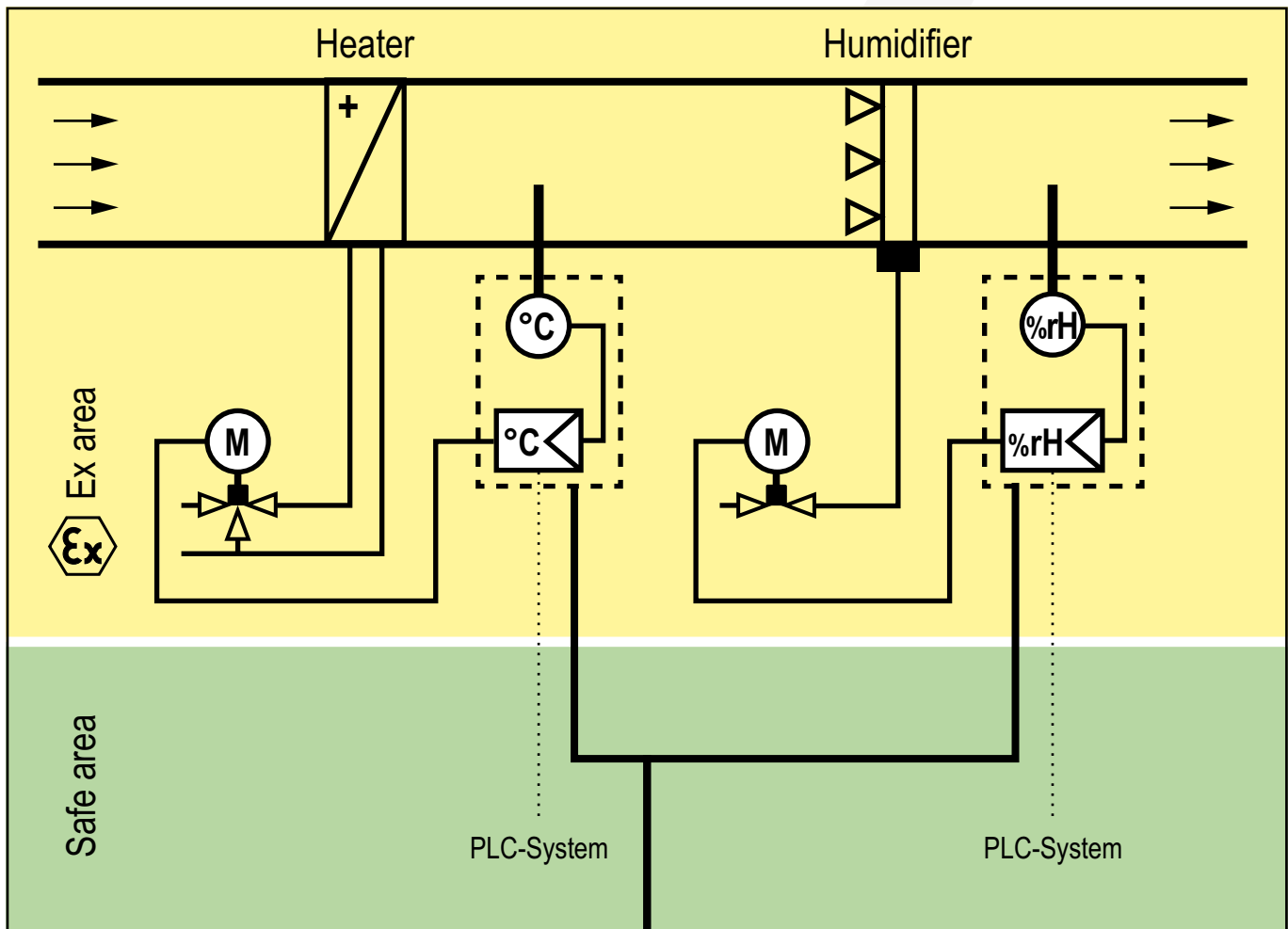



**Controller**

**ExReg-D-..  
Temperature/Humidity**

- -40°C...+125°C
- 0...100 %rH

### ExReg-D-../InReg-D-.. Temperature °C/humidity %rH controller

Explosion proof	Industrial	Features ExReg-D-..., InReg-D-..	
<p><b>ExReg-D-..</b></p> <p>Zone 1, 2, 21, 22 Gas + Dust certified according to ATEX, IECEx</p> 	<p><b>InReg-D-..</b></p> <p>NOT explosion proof and only for use in safe area IP66</p> 	<p><b>Description</b></p> <p>Compact temperature or humidity controller for use in hazardous locations zone 1, 2, 21, 22 or in safe area (depending on type). Suitable actuator ..Max-...-CY, ..Max-...-CYF or ..Run-.. available separately.</p> <p><b>Delivery:</b> Electric temperature or humidity controller with integrated terminal box (ExReg-.. with "Ex-e") and connection for 1 ExPro-C-../InPro-C-.. sensor, 3 tapping screws</p>	<p><b>Basics</b></p> <ul style="list-style-type: none"> <li>• No additional module in the panel required</li> <li>• No intrinsically safe wiring required</li> <li>• Meas. range -40...+125 °C/0...100 %rH</li> <li>• 24 VAC/DC</li> <li>• Switch-on delay 3 seconds</li> <li>• PID controller</li> <li>• Programmable w/o additional tools</li> <li>• Alarm with alarm delay function</li> <li>• LCD backlight (which can be switched off)</li> <li>• Aluminium housing, protection IP66</li> <li>• Integrated terminal box (ExReg-.. with "Ex-e")</li> <li>• Optional offshore/marine coated or stainless steel edition</li> <li>• H x W x D = 180 x 107 x 66 mm</li> </ul>

### ExReg-D-.. Temperature/humidity controller for zone 1, 2, 21, 22

Type	Sensor	Supply	Meas. range	Connection/Interface (analogue)	Installation
ExReg-D-A	ExPro-C-..	24 VAC/DC	-40...+125 °C/0...100 %rH	1 x actuator, 1 x set point, 1 x actual value, 1 x position actuator	zone 1, 2, 21, 22

### InReg-D-.. Temperature/humidity controller for safe area

Type	Sensor	Supply	Meas. range	Connection/Interface (analogue)	Installation
InReg-D-A	InPro-C-..	24 VAC/DC	-40...+125 °C/0...100 %rH	1 x actuator, 1 x set point, 1 x actual value, 1 x position actuator	safe area

### Actuators for ..Reg.. controller

Type	Torque	Running time 90°	Spring return	Control mode	Feedback	Features	Size
ExMax- 5.10-CY	5 Nm / 10 Nm	7,5/15/30/60/120 sec.	-	4...20 mA	0...10 V	combination with ExReg-..	S
ExMax-15.30-CY	15 Nm / 30 Nm	7,5/15/30/60/120 sec.	-	4...20 mA	0...10 V	combination with ExReg-..	S
ExMax- 5.10-CYF	5 Nm / 10 Nm	7,5/15/30/60/120 sec.	~ 10 sec.	4...20 mA	0...10 V	combination with ExReg-..	S
ExMax-15- CYF	15 Nm	7,5/15/30/60/120 sec.	~ 10 sec.	4...20 mA	0...10 V	combination with ExReg-..	S
InMax- 5.10-CY	5 Nm / 10 Nm	7,5/15/30/60/120 sec.	-	4...20 mA	0...10 V	combination with InReg-..	S
InMax- 15.30-CY	15 Nm / 30 Nm	7,5/15/30/60/120 sec.	-	4...20 mA	0...10 V	combination with InReg-..	S
InMax- 5.10-CYF	5 Nm / 10 Nm	7,5/15/30/60/120 sec.	~ 10 sec.	4...20 mA	0...10 V	combination with InReg-..	S
InMax- 15- CYF	15 Nm	7,5/15/30/60/120 sec.	~ 10 sec.	4...20 mA	0...10 V	combination with InReg-..	S

### Sensors for ..Reg-D-.. controller

Type	Description/Technical data
ExPro-CT-..	Temperature sensors for connection on ExReg-D-.. controller, installation in zone 1, 2, 21, 22
ExPro-CF-..	Humidity sensors for connection on ExReg-D-.. controller, installation in zone 1, 2, 21, 22
InPro- CT-..	Temperature sensors for connection on InReg-D-.. controller, installation in safe area
InPro- CF-..	Humidity sensors for connection on InReg-D-.. controller, installation in safe area

Combi sensors not applicable!  
Details see on page 39

### Accessories

Type	Description/Technical data
MKR-VA/AL	Mounting bracket for installation on round air-ducts (diameter up to 600 mm)
VL3	Sensor extension cable 3 m

Special options and offshore kits see page 52

## ExCos – Analog sensor series for hazardous locations !

Measurement applications for differential pressure, temperature and humidity ...



HAZARDOUS LOCATIONS ZONE 1, 2, 21, 22

NO TRANSMITTER IN PANEL NEEDED

NO INTRINSIC SAFE CIRCUITS NEEDED

EASY INSTALLATION

EASY PARAMETERISATION

REDUCED INSTALLATION COST

ACTUAL VALUE INDICATION

OFFSHORE/MARINE COATED VERSION

STAINLESS STEEL SOLUTION

## Content overview

Product series		Page
<b>Analog sensors for measuring of volume flow, temperature, humidity, pressure/differential pressure</b>		
Overview	analog sensors	34/36
ExCos-P	differential pressure, VAV sensors ± 100... 7.500 Pa	37
RedCos-P	differential pressure, VAV sensors ± 100... 7.500 Pa	37
InCos-P	differential pressure, VAV sensors ± 100... 7.500 Pa	37
ExCos-D	temperature and humidity transmitter for ExPro-C... sensors	38
RedCos-D	temperature and humidity transmitter for ExPro-C... sensors	38
InCos-D	temperature and humidity transmitter for InPro-C... sensors	38
ExPro-C...	temperature and humidity sensors for operation in HVAC systems	39
InPro-C...	temperature and humidity sensors for operation in HVAC systems	39
ExLine	transmitter EXL-IM-9182... for passive, potential free, analog ExSens sensors	40
ExSens	analog, passive temperature-/humidity-/pressure sensors	41
<b>Special options for sensors</b>		
Overview	special options for sensors	52
Overview	heating system ..Polar for sensors	53
ExPolar/ExArctic	heating system for sensors' use in Ex areas down to -40/-60 °C	53
InPolar/InArctic	heating system for sensors' use in safe area down to -40/-60 °C	53

Installation areas						
Gas 0	Dust 20	Gas 1	Dust 21	Gas 2	Dust 22	SA*
		●	●	●	●	
		●	●	●	●	●
		●	●	●	●	●
		●	●	●	●	●
		●	●	●	●	●
		●	●	●	●	●
(●)	(●)	●	(●)	●	●	●
		●	●	●	●	●

\*SA = Safe area (●) = on request



## ExCos-../RedCos-../InCos-.. Sensors with analog output – Overview

### Overview of the ExCos-.., RedCos-.. and InCos-.. sensor technology

**Installation areas:**

- ExCos-..... Sensors for use in hazardous locations zone 1, 2, 21, 22
- RedCos-..... Sensors for use in hazardous locations zone 2, 22
- InCos-..... Sensors for safe area

**Application areas:**

- Ex/Red/InCos-P..... Sensors for pressure and differential pressure
- Ex/Red/InCos-D + ..Pro-C..... Sensors (active) for temperature and/or humidity
- EXL-IM-9182-.. (Ex-i) + ExSens..... Sensors (passive) for temperature, humidity and potentiometer

**The sensor concept offers especially in Ex-area huge benefits:**

1. No intrinsically safe wiring required between the control panel and the sensor
2. No intrinsically safe circuit necessary inside the control panel
3. No transmitter needed in the electrical control panel
4. Reduced installation cost
5. Easy installation
6. Easy parameterisation
7. Cost savings for electrical components
8. Actual value indication
9. Optional in stainless steel (AISI 316) or with offshore/marine coating

**ΔP**  
**ExCos-P**

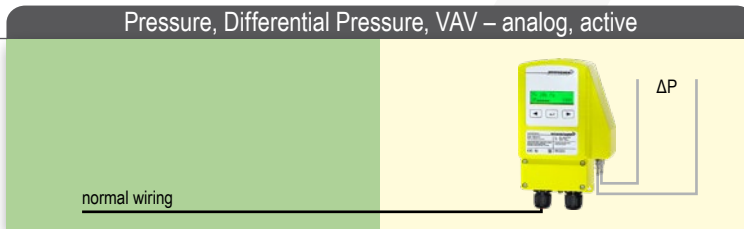

**ExCos-P-.., RedCos-P-.., InCos-P-.. Sensors**

Transmitter with integrated differential-pressure sensor for direct connection of the air-hoses. IP66 aluminium housing with integrated terminal-box. Measuring range parametrizable on site. Outputs 0...10 V/4...20 mA. Integrated actual value indication, illuminated.

**°C**  
**%rH**  
**ExCos-D**  
**+ ExPro-C..**

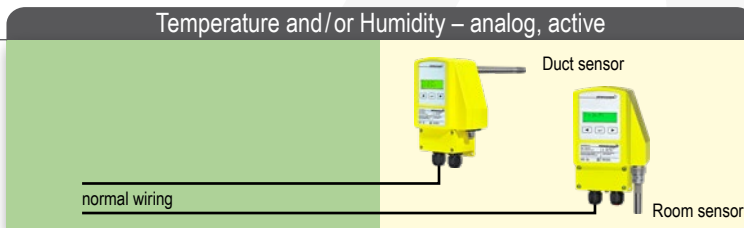

**ExCos-D, RedCos-D, InCos-D Transmitter + ExPro-C.., InPro-C.. sensor**

Transmitter for the installation of an ExPro-C.. or InPro-C.. (with InCos-D) for temperature °C and/or humidity in %. IP66 aluminium housing with integrated terminal box. Measuring range parametrizable on site. Outputs 0...10 V/4...20 mA. Integrated actual value indication, illuminated.

**°C**  
**%rH**  
**EXL-IM-..**  
**+ ExSens**

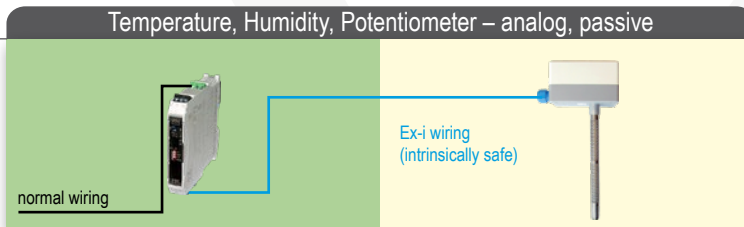

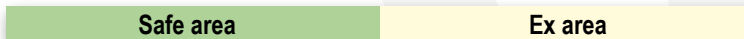

**EXL-IM-.. transmitter + ExSens sensor**

Transmitter for a connection of a passive, analog ExSens sensor type Pt 100, Ni 1000, 0...10 kΩ over Ex-i electrical conduit. Installation in control box onto DIN-rail. Measuring range parametrizable on site. Outputs 4...20 mA (with additional plug 0...10 V).



## ExCos-P/RedCos-P/InCos-P Differential pressure transmitter

Explosion proof		Industrial	Features of ExCos-P-.., RedCos-P-.., InCos-P-..	
<p><b>ExCos-P-..</b></p> <p>Zone 1, 2, 21, 22 Gas + Dust certified according to ATEX, IECEx, EAC, KOSHA</p> 	<p><b>RedCos-P-..</b></p> <p>Zone 2, 22 Gas + Dust certified according to ATEX, IECEx, EAC, CSA</p> 	<p><b>InCos-P-..</b></p> <p>NOT Explosion proof and only for use in safe area IP66</p> 	<p><b>Description</b></p> <p>ExCos-P-.., RedCos-P-.. and InCos-P-.. are pressure transmitter for HVAC systems, e.g. for differential pressure control.</p> <p><b>Delivery:</b> 1 sensor with integrated terminal box, 3 tapping screws, short circuit tube</p>	<p><b>Basics</b></p> <ul style="list-style-type: none"> <li>• No additional module in the panel required!</li> <li>• No intrinsically safe wiring required!</li> <li>• 24 VAC/DC supply</li> <li>• Outputs 0...10 V, (0)4...20 mA selectable</li> <li>• Measurement range adjustable</li> <li>• Actual value indication (which can be switched off)</li> <li>• All parameters can be adjusted on site without additional tools and measurement devices</li> <li>• Aluminium housing IP66</li> <li>• Integrated terminal box (ExCos-.. with "Ex-e")</li> <li>• Dimensions (H x W x D) 180 x 107 x 66 mm</li> </ul>

### ExCos-P-.. Differential pressure and volume control transmitter for zone 1, 2, 21, 22

Type	Max. range	Overload protected	Measurement range, min. 20% of max. range	Installation module
ExCos-P- 100	± 100 Pa	up to 25.000 Pa	± Measurement range free adjustable, min. range 20 Pa	zone 1, 2, 21, 22
ExCos-P- 250	± 250 Pa	up to 25.000 Pa	± Measurement range free adjustable, min. range 50 Pa	zone 1, 2, 21, 22
ExCos-P- 500	± 500 Pa	up to 50.000 Pa	± Measurement range free adjustable, min. range 100 Pa	zone 1, 2, 21, 22
ExCos-P-1250	± 1.250 Pa	up to 50.000 Pa	± Measurement range free adjustable, min. range 250 Pa	zone 1, 2, 21, 22
ExCos-P-2500	± 2.500 Pa	up to 50.000 Pa	± Measurement range free adjustable, min. range 500 Pa	zone 1, 2, 21, 22
ExCos-P-5000	± 5.000 Pa	up to 75.000 Pa	± Measurement range free adjustable, min. range 1.000 Pa	zone 1, 2, 21, 22
ExCos-P-7500	± 7.500 Pa	up to 120.000 Pa	± Measurement range free adjustable, min. range 1.500 Pa	zone 1, 2, 21, 22

### RedCos-P-.. Differential pressure and volume control transmitter for zone 2, 22

Type	Max. range	Overload protected	Measurement range, min. 20% of max. range	Installation module
RedCos-P- 100	± 100 Pa	up to 25.000 Pa	± Measurement range free adjustable, min. range 20 Pa	zone 2, 22
RedCos-P- 250	± 250 Pa	up to 25.000 Pa	± Measurement range free adjustable, min. range 50 Pa	zone 2, 22
RedCos-P- 500	± 500 Pa	up to 50.000 Pa	± Measurement range free adjustable, min. range 100 Pa	zone 2, 22
RedCos-P-1250	± 1.250 Pa	up to 50.000 Pa	± Measurement range free adjustable, min. range 250 Pa	zone 2, 22
RedCos-P-2500	± 2.500 Pa	up to 50.000 Pa	± Measurement range free adjustable, min. range 500 Pa	zone 2, 22
RedCos-P-5000	± 5.000 Pa	up to 75.000 Pa	± Measurement range free adjustable, min. range 1.000 Pa	zone 2, 22
RedCos-P-7500	± 7.500 Pa	up to 120.000 Pa	± Measurement range free adjustable, min. range 1.500 Pa	zone 2, 22

### InCos-P-.. Differential pressure and volume control transmitter for safe area



Type	Max. range	Overload protected	Measurement range, min. 20% of max. range	Installation module
InCos-P- 100	± 100 Pa	up to 25.000 Pa	± Measurement range free adjustable, min. range 20 Pa	safe area
InCos-P- 250	± 250 Pa	up to 25.000 Pa	± Measurement range free adjustable, min. range 50 Pa	safe area
InCos-P- 500	± 500 Pa	up to 50.000 Pa	± Measurement range free adjustable, min. range 100 Pa	safe area
InCos-P-1250	± 1.250 Pa	up to 50.000 Pa	± Measurement range free adjustable, min. range 250 Pa	safe area
InCos-P-2500	± 2.500 Pa	up to 50.000 Pa	± Measurement range free adjustable, min. range 500 Pa	safe area
InCos-P-5000	± 5.000 Pa	up to 75.000 Pa	± Measurement range free adjustable, min. range 1.000 Pa	safe area
InCos-P-7500	± 7.500 Pa	up to 120.000 Pa	± Measurement range free adjustable, min. range 1.500 Pa	safe area

### Accessories and special designs

Type	Description/Technical data
MKR-VA/AL	Mounting bracket for installation on round air-ducts (diameter up to 600 mm)
Kit 2	Includes 2 meter pressure hose (inner diameter 6 mm) and 2 plastic fittings

Special options and offshore kits see page 52

### ExCos-D/RedCos-D/InCos-D Temperature/humidity transmitter

Explosion proof		Industrial	Features ExCos-D, RedCos-D, InCos-D	
<p><b>ExCos-D</b></p> <p>Zone 1, 2, 21, 22 Gas + Dust certified according to ATEX, IECEx, EAC, KOSHA</p> 	<p><b>RedCos-D</b></p> <p>Zone 2, 22 Gas + Dust certified according to ATEX, IECEx, EAC, CSA</p> 	<p><b>InCos-D</b></p> <p>NOT Explosion proof and only for use in safe area IP66</p> 	<p><b>Description</b></p> <p>ExCos-D, RedCos-D and InCos-D transmitter together with ExPro-C.../InPro-C... sensors are for temperature and/or humidity measurement in HVAC systems.</p> <p><b>Delivery:</b> 1 transmitter with connection for 1 ExPro-C... sensor, 3 tapping screws</p> <p><b>Required accessory (additional price):</b> 1 ExPro-C... or InPro-C... sensor</p> <p><b>Ordering example</b> for temperature duct sensing in hazardous location in zone 21, 150 mm sensor tube.</p> <p><b>Types to order:</b> 1 × ExCos-D 1 × ExPro-CT-150</p>	<p><b>Basics</b></p> <ul style="list-style-type: none"> <li>• No additional module in the panel required!</li> <li>• No intrinsically safe wiring required!</li> <li>• 24 VAC/DC supply</li> <li>• Connector for ExPro-C... sensors for room or duct mounting</li> <li>• Outputs 0...10 V, 4...(0)20 mA selectable</li> <li>• Measurement range adjustable</li> <li>• Actual value indication (which can be switched off)</li> <li>• All parameters can be adjusted on site without additional tools and measurement devices</li> <li>• Aluminium housing IP66</li> <li>• Integrated terminal box (ExCos.. with "Ex-e")</li> <li>• Dimensions (H × W × D) 180 × 107 × 66 mm</li> </ul>

#### ExCos-D temperature-/humidity module for zone 1, 2, 21, 22

Type	Description/Technical data	Installation module	Installation ExPro sensor
ExCos-D	Module to connect 1 ExPro-C... sensor for temperature and/or humidity for use in hazardous locations	zone 1, 2, 21, 22	zone 1, 2, 21, 22

#### RedCos-D temperature-/humidity module for zone 2, 22

Type	Description/Technical data	Installation module	Installation ExPro sensor
RedCos-D	Module to connect 1 ExPro-C... sensor for temperature and/or humidity for use in hazardous locations	zone 2, 22	zone 1, 2, 21, 22

#### InCos-D temperature-/humidity module for safe area

Type	Description/Technical data	Installation module	Installation InPro sensor
InCos-D	Module to connect 1 InPro-C... sensor for temperature and/or humidity for use in safe area	safe area	safe area

#### Accessories and special designs

Type	Description/Technical data
MKR-VAJAL	Mounting bracket for installation on round air-ducts (diameter up to 600 mm)
VL3	Sensor extension cable 3 m

Special options and offshore kits see page 52

#### Example of combinations

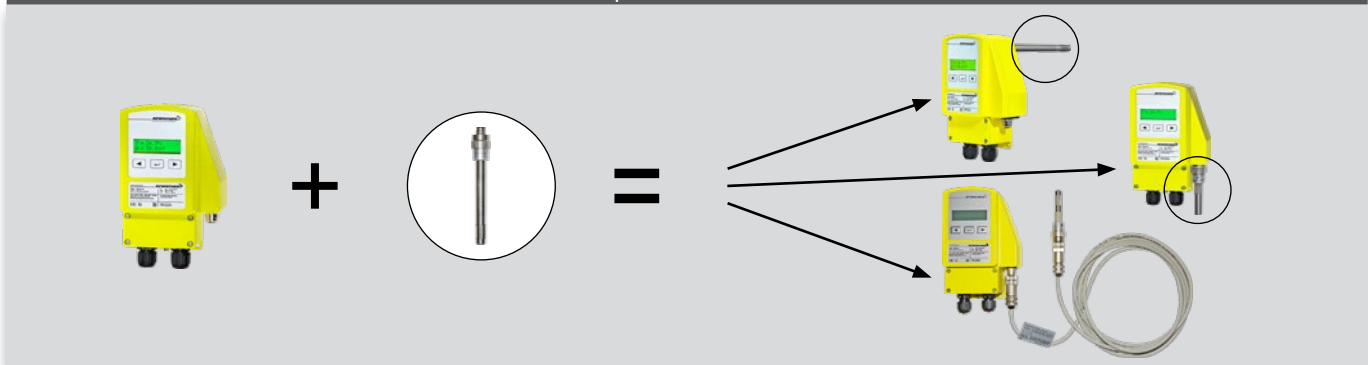

## ExPro-C../InPro-C.. Temperature/humidity sensors

### Explosion proof

### Industrial

### Features ExPro-C..., InPro-C..

#### ExPro-C..

Zone 1, 2, 21, 22  
Gas + Dust  
EC type-approved  
with ExCos-D/RedCos-D  
transmitter



#### InPro-C..

Only for use with  
InCos-D... transmitter!  
**NOT** for use in  
Ex area!



#### Description

ExPro-C.. sensors are used for measurements of temperature and/or humidity in hazardous locations, for **exclusive** use with ExCos-D/RedCos-D transmitter!

InPro-C.. sensors are suitable for temperature and/or humidity measurement in safe areas, for **exclusive** use with InCos-D transmitter!

**Delivery:** 1 sensor with connector

**Example:** room-humidity sensor, 50 mm length  
**Type:** 1 x ExPro-CF-50

**Attention:** only in combination with:  
1 x ExCos-D or RedCos-D transmitter  
(InCos-D by InPro-C.. sensors)

#### Basics

- ExPro-C.. Sensors for connection to ExCos-D or RedCos-D transmitter (InPro-C.. sensors for InCos-D transmitter)
- Mechanical and electrical adaptation via connector
- ExPro-C../InPro-C.. sensors can be screwed to the housing optionally at the back (duct measurement) or bottom (room measurement)
- When using humidity-sensors, the contamination and aggressiveness of the medium has to be regarded

### Sensors for ExCos-D and RedCos-D transmitter

Type	Function	Range	Sensor length	Main use	Connectable to	Installation area
ExPro-CT - 50	Temperature sensor	-40...+ 80 °C	50 mm	Room/Duct	ExCos-D RedCos-D	zone 1, 2, 21, 22
ExPro-CT -100	Temperature sensor	-40...+ 125 °C	100 mm	Duct	ExCos-D RedCos-D	zone 1, 2, 21, 22
ExPro-CT -150	Temperature sensor	-40...+ 125 °C	150 mm	Duct	ExCos-D RedCos-D	zone 1, 2, 21, 22
ExPro-CT -200	Temperature sensor	-40...+ 125 °C	200 mm	Duct	ExCos-D RedCos-D	zone 1, 2, 21, 22
ExPro-CF - 50	Humidity sensor	0...100 %rF	50 mm	Room/Duct	ExCos-D RedCos-D	zone 1, 2, 21, 22
ExPro-CF -100	Humidity sensor	0...100 %rF	100 mm	Duct	ExCos-D RedCos-D	zone 1, 2, 21, 22
ExPro-CF -150	Humidity sensor	0...100 %rF	150 mm	Duct	ExCos-D RedCos-D	zone 1, 2, 21, 22
ExPro-CF -200	Humidity sensor	0...100 %rF	200 mm	Duct	ExCos-D RedCos-D	zone 1, 2, 21, 22
ExPro-CTF- 50	Combination temperature/humidity	-40...+ 80 °C, 0...100 %rH	50 mm	Room/Duct	ExCos-D RedCos-D	zone 1, 2, 21, 22
ExPro-CTF-100	Combination temperature/humidity	-40...+ 125 °C, 0...100 %rH	100 mm	Duct	ExCos-D RedCos-D	zone 1, 2, 21, 22
ExPro-CTF-150	Combination temperature/humidity	-40...+ 125 °C, 0...100 %rH	150 mm	Duct	ExCos-D RedCos-D	zone 1, 2, 21, 22
ExPro-CTF-200	Combination temperature/humidity	-40...+ 125 °C, 0...100 %rH	200 mm	Duct	ExCos-D RedCos-D	zone 1, 2, 21, 22

### Sensors for InCos-D transmitter

Type	Function	Range	Sensor length	Main use	Connectable to	Installation area
InPro-CT - 50	Temperature sensor	-40...+ 80 °C	50 mm	Room/Duct	InCos-D	safe area
InPro-CT -100	Temperature sensor	-40...+ 125 °C	100 mm	Duct	InCos-D	safe area
InPro-CT -150	Temperature sensor	-40...+ 125 °C	150 mm	Duct	InCos-D	safe area
InPro-CT -200	Temperature sensor	-40...+ 125 °C	200 mm	Duct	InCos-D	safe area
InPro-CF - 50	Humidity sensor	0...100 %rF	50 mm	Room/Duct	InCos-D	safe area
InPro-CF -100	Humidity sensor	0...100 %rF	100 mm	Duct	InCos-D	safe area
InPro-CF -150	Humidity sensor	0...100 %rF	150 mm	Duct	InCos-D	safe area
InPro-CF -200	Humidity sensor	0...100 %rF	200 mm	Duct	InCos-D	safe area
InPro-CTF- 50	Combination temperature/humidity	-40...+ 80 °C, 0...100 %rH	50 mm	Room/Duct	InCos-D	safe area
InPro-CTF-100	Combination temperature/humidity	-40...+ 125 °C, 0...100 %rH	100 mm	Duct	InCos-D	safe area
InPro-CTF-150	Combination temperature/humidity	-40...+ 125 °C, 0...100 %rH	150 mm	Duct	InCos-D	safe area
InPro-CTF-200	Combination temperature/humidity	-40...+ 125 °C, 0...100 %rH	200 mm	Duct	InCos-D	safe area

### Accessories

Type	Description/Technical data
MFK	Mounting flange for duct-installation, for variable depth of immersion in the air duct
TH- VA	Probe made of stainless-steel V4A 1.4571, length 150 mm for ..Pro-CT-200. Other lengths on request
Kit-FA-VA	Sinter filter cap for humidity sensor (only up to 90 %rH)
MKR-VA/AL	Mounting bracket for installation on round air-ducts (diameter up to 600 mm)

## ExLine Ex-transmitter with Ex-i circuit for zone 0, 1, 2, 20, 21, 22

Explosion proof

Features EXL-IM-9182-10-51-11s C2305 TMU

EXL-IM-9182-..	EXL-IM-9182-..	Description	Basics
<p>Zone 0, 1, 2, 20, 21, 22 Gas + Dust certified according to ATEX, IECEx, CSA, FM/UL, EAC, INMETRO, KOSHA, PESO</p>	<p><b>NEW</b></p> 	<p>Module with intrinsically safe circuit to change a passive sensor signal (e.g. PT100) into an active mA/V signal. Module must be installed in the safe area, sensor in the hazardous location!</p> <p><b>Delivery:</b> 1 Ex-i module for DIN rail mounting</p> <p><b>Accessory (optional):</b> analog sensors type ExSens</p>	<ul style="list-style-type: none"> <li>• 24 V DC power supply</li> <li>• Inverse-polarity protection</li> <li>• Transmitter for passive, potential free, analog sensors series ExSens, 2-3-4-wire connection</li> <li>• Simple configuration via software or DIP-switches</li> <li>• Input: PT100, PT500, PT1000, Ni100, Ni500, Ni1000, 0...1.000 Ohm</li> <li>• Output: 4...20 mA, with additional plug 0...10 V</li> <li>• LED operation indication</li> <li>• Dimensions (W × H × D) 17,6 × 99 × 114,5 mm</li> <li>• Rail mounting according DIN, installation in safe area</li> </ul>

### EXL-IM-9182-10-51-11s C2305 TMU transmitter

Type	Description/Technical data	Installation module	Installation sensor*
EXL-IM-9182-..	1 module (rail mounting) for 1 passive sensor series ExSens	safe area	zone 0, 1, 2, 20, 21, 22
<b>Optional:</b>			
<b>Plug 0-10V-9182</b>	for output 0...10 V (installation in safe area)		
<b>N1 supply unit</b>	Input 120...240 VAC, output 24 VDC, max. 0,5 A, max. 4 pcs. EXL-IM... connectable. N1 supply unit is required only in case of 120...240 VAC supply!		

\*in acc. with certification of sensor!



## ExSens passive analog sensors for zone 1, 2, 21, 22

Explosion proof

Features analog ExSens sensors

### ExSens

Zone 1, 2, 21, 22  
Gas + Dust  
certified according to  
ATEX  
Manufacturer certificate

### passive



### Description

ExSens sensors for temperature, humidity or pressure measurement in hazardous locations with manufacturer certification in acc. with ATEX directives. The sensors are passive and potential free.

**Delivery:** 1 Sensor  
**Ordering example** for 1 room humidity sensor  
**Type to purchase:** 1 × FFR-2G

### Basics

- Sensors for installation in hazardous locations, connected to a relevant transmitter, for e.g. EXL-IM-9182-...
- The transmitter changes the passive resistance signal into an active 4...20 mA signal (with additional plug 0...10 V)
- Sensor is installed in the hazardous location, module in the safe area

### Sensors, connectable to transmitter EXL-IM-9182-...

Type	Function	Measuring range	Sensor	Connectable to transmitter	Sensor in zone
TFR -2G	Room temperature	-30...+ 60 °C	Pt 100 DIN	EXL-IM-9182-...	1, 2
TFR -2G3D	Room temperature (IP65)	-40...+ 60 °C	Pt 100 DIN	EXL-IM-9182-...	1, 2, 22
TFK -2G3D	Duct temperature (IP65), 200 mm	-30...+150 °C	Pt 100 DIN	EXL-IM-9182-...	1, 2, 22
TFK -2G3D-400	Duct temperature, length 400 mm	-30...+150 °C	Pt 100 DIN	EXL-IM-9182-...	1, 2, 22
TFT -2G3D	Sensor temperature (IP65), 100 mm	-30...+150 °C	Pt 100 DIN, tubing G½" Ms	EXL-IM-9182-...	1, 2, 22
TFT-V4A-2G3D	Sensor temperature (IP65), 100 mm	-30...+150 °C	Pt 100 DIN, tubing G½" VA	EXL-IM-9182-...	1, 2, 22
TFM -2G-3	Mean value temperature 3 m	-20...+ 70 °C	Pt 100 DIN	EXL-IM-9182-...	1, 2
TFR-AN -2G3D	Room temperature direct contact	-30...+110 °C	Pt 100 DIN	EXL-IM-9182-...	1, 2, 22
FFR -2G	Room humidity	30...100 %rF	0...1 kΩ	EXL-IM-9182-...	1, 2
FFK -2G	Duct humidity	30...100 %rF	0...1 kΩ	EXL-IM-9182-...	1, 2
TFFR -2G	Room combination temp./humidity	30...100 %rF, -10...+60 °C	0...1 kΩ, Pt 100	2 × EXL-IM-9182-...	1, 2
TFFK -2G	Duct combination temp./humidity	30...100 %rF, -20...+60 °C	0...1 kΩ, Pt 100	2 × EXL-IM-9182-...	1, 2
DFK-07 -2G-FP	Differential pressure (IP65)	ΔP < 700 Pa	x...y Ω	EXC-5114B2A-RW-MA (Milliamp output), EXC-5114B2A-RW-V (Volt output)	1, 2
DFK-17 -2G-FP	Differential pressure (IP65)	ΔP < 1700 Pa	x...y Ω	EXC-5114B2A-RW-MA (Milliamp output), EXC-5114B2A-RW-V (Volt output)	1, 2
VFK-07 -2G-FP	Volume control (IP65)	0...15 m/s	x...y Ω	on request	1, 2
SGR -2G	Potentiometer	Resistance	0...1 kΩ	EXL-IM-9182-...	1, 2

## ExBin – Switching sensor series for hazardous locations!

Applications for differential pressure, temperature, humidity, fan belt monitoring and frost protection ...

HAZARDOUS LOCATIONS ZONE 1, 2, 21, 22

NO MODULE IN PANEL NEEDED

NO INTRINSIC SAFE CIRCUITS NEEDED

EASY INSTALLATION

EASY PARAMETERISATION

REDUCED INSTALLATION COST

ACTUAL VALUE INDICATION

OFFSHORE/MARINE COATED VERSION

STAINLESS STEEL SOLUTION





## ExBin-../RedBin-../InBin-.. Sensors with switching output (relay) – Overview

### Overview of the ExBin-..., RedBin-... and InBin-... sensor technology

**Installation areas:**









**ExBin-.....** Sensors for use in hazardous locations zone 1, 2, 21, 22  
**RedBin-.....** Sensors for use in hazardous locations zone 2, 22  
**InBin-.....** Sensors for safe area

**Application areas:**



**Ex/Red/InBin-P.....** Sensors for pressure and differential pressure monitoring  
**Ex/Red/InBin-FR.....** Sensors for frost protection monitoring  
**Ex/Red/InBin-D + ..Pro-B.....** Sensors (active) for temperature and/or humidity monitoring  
**Ex/Red/InBin-A + ExSens.....** Sensors (passive) for temperature, humidity, pressure monitoring  
**EXL-IR-9170-.. (Ex-i) + ExSens.....** Sensors (passive) for temperature, humidity, pressure, filter and fan monitoring

**The binary sensor concept offers especially in Ex-area huge benefits:**

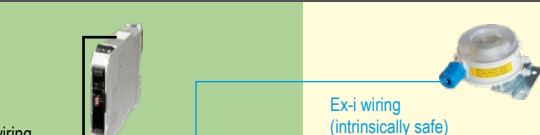
1. No intrinsically safe wiring required between the control panel and the sensor
2. No intrinsically safe circuit necessary inside the control panel
3. No switching module needed in the electrical control panel
4. Reduced installation cost
5. Easy installation
6. Easy parameterisation
7. 1- and 2-stage versions available
8. Actual value indication
9. Optional in stainless steel (AISI 316) or with offshore/marine coating

<p><b>ΔP</b> <b>ExBin-P</b></p> 	<p><b>Pressure, differential pressure (Filter/fan belt monitoring) – active</b></p>  <p>normal wiring</p>	<p><b>ExBin-P-..., RedBin-P-..., InBin-P-..</b></p> <p>Binary pressure/differential pressure auxiliary switch 0...5.000 Pa, for direct connection of air hoses. IP66 Aluminium die-cast housing with integrated terminal box. Set points adjustable on site, output 1 potential-free make contact. Integrated indication of actual value, illuminated. 2-stage version optionally available.</p>
<p><b>°C</b> <b>ExBin-FR</b></p> 	<p><b>Frost protection thermostats – active</b></p>  <p>normal wiring</p>	<p><b>ExBin-FR-..., RedBin-FR-..., InBin-FR-..</b></p> <p>Frost protection thermostat mechanically adjustable and switching. Setting range -10...+15 °C. 3 or 6 m capillary as sensor with a resolution of 40 cm effective range. Switching status display with LED. IP66 Aluminium die-cast housing with integrated terminal box. Output 1 potential-free make contact.</p>
<p><b>°C</b> <b>%rH</b> <b>ExBin-D + ExPro-B..</b></p> 	<p><b>Thermostats, hygrometers – active</b></p>  <p>normal wiring</p>	<p><b>ExBin-D, RedBin-D, InBin-D + ExPro-B.. respectively InPro-B.. Sensor</b></p> <p>Thermostats and/or hygrometers for connection of one ExPro-B.. respectively InPro-B.. sensor. Operating range adjustable. Indication of actual value. IP66 Aluminium die-cast housing with integrated terminal box. Output 1 potential-free make contact. 2-stage version optionally available.</p>
<p><b>°C</b> <b>%rH</b> <b>ΔP</b> <b>ExBin-A + ExSens</b></p> 	<p><b>1- or 2-channel switching module for passive sensors</b></p>  <p>normal wiring</p>	<p><b>ExBin-A1/A2, RedBin-A1/A2 + ExSens switching sensors</b></p> <p>1- or 2-channel Ex-switching module for connection of max. 2 passive, potential-free switching sensors. Switching status display with LED. IP66 Aluminium die-cast housing with integrated terminal box. Output depending on type 1-2 make contacts with collective supply unit.</p>
<p><b>°C</b> <b>%rH</b> <b>ΔP</b> <b>EXL-IR-.. + ExSens</b></p> 	<p><b>Temperature, humidity, diff. pressure switching module for passive sensors</b></p>  <p>normal wiring</p>	<p><b>EXL-IR-.. switching module + ExSens sensor</b></p> <p>Ex-switching module for connection of one passive, switching ExSens sensor, such as differential pressure switch, frost protection thermostat or hygrometer through intrinsically safe electrical conduit. Installation in control box onto DIN-rail. Output is potential-free.</p>
<p><b>Safe area</b>   <b>Ex area</b></p>		

ExBin-P/RedBin-P/InBin-P Pressure/differential pressure switch, binary

Explosion proof			Industrial	Features of ExBin-P-..., RedBin-P-..., InBin-P-...	
<p><b>ExBin-P-..</b></p> <p>Zone 1, 2, 21, 22 Gas + Dust certified according to ATEX, IECEx, EAC, KOSHA</p> 	<p><b>RedBin-P-..</b></p> <p>Zone 2, 22 Gas + Dust certified according to ATEX, IECEx, EAC, CSA</p> 	<p><b>InBin-P-..</b></p> <p>NOT Explosion proof and only for use in safe area IP66</p> 	<p><b>Description</b></p> <p>ExBin-P-..., RedBin-P-... and InBin-P-... are pressure switches for HVAC systems, e.g. for differential pressure control for filter- or fan belt monitoring.</p> <p>..Bin-P-100 pressure switch allows an achievement of new applications with a smaller differential pressure range.</p> <p>Additionally the ..Bin-P-100 has an adjustable switch activation delay contact for applications which require a time-delayed fault indication, for example short opening of doors in clean room environment.</p> <p><b>Delivery:</b> 1 Pressure switch with integrated terminal box, 3 tapping screws</p>	<p><b>Basics</b></p> <ul style="list-style-type: none"> <li>• No additional module in the panel required!</li> <li>• No intrinsically safe wiring required!</li> <li>• 24 VAC/DC supply</li> <li>• 1-channel: 1 potential-free contact</li> <li>• 2-channel (optional): 2 potential-free contacts</li> <li>• Switch-point is digitally adjustable</li> <li>• Indication of actual value (can be switched off)</li> <li>• Switching status display over LED</li> <li>• All parameters can be adjusted on site without additional tools and measurement devices</li> <li>• Aluminium housing IP66</li> <li>• Integrated terminal box (ExBin.. with "Ex-e")</li> <li>• ..Bin-P-100 with switch activation delay, adjustable from 0...240 s</li> <li>• Dimensions (H × W × D) 180 × 107 × 66 mm</li> </ul>	

ExBin-P-.. Differential pressure switch for zone 1, 2, 21, 22

Type	Measurement range	Safe overload	Setting range	Special feature	Installation module
ExBin-P- 100	0... 100 Pa	up to 5.000 Pa	1-stage adjustable switch-point in meas. range	adjustable switch activation delay 0...240 s	zone 1, 2, 21, 22
ExBin-P- 500	0... 500 Pa	up to 5.000 Pa	1-stage adjustable switch-point in meas. range		zone 1, 2, 21, 22
ExBin-P- 500-2	0... 500 Pa	up to 5.000 Pa	2-stage adjustable switch-point in meas. range		zone 1, 2, 21, 22
ExBin-P-5000	0...5.000 Pa	up to 50.000 Pa	1-stage adjustable switch-point in meas. range		zone 1, 2, 21, 22
ExBin-P-5000-2	0...5.000 Pa	up to 50.000 Pa	2-stage adjustable switch-point in meas. range		zone 1, 2, 21, 22

RedBin-P-.. Differential pressure switch for zone 2, 22

Type	Measurement range	Safe overload	Setting range	Special feature	Installation module
RedBin-P- 100	0... 100 Pa	up to 5.000 Pa	1-stage adjustable switch-point in meas. range	adjustable switch activation delay 0...240 s	zone 2, 22
RedBin-P- 500	0... 500 Pa	up to 5.000 Pa	1-stage adjustable switch-point in meas. range		zone 2, 22
RedBin-P- 500-2	0... 500 Pa	up to 5.000 Pa	2-stage adjustable switch-point in meas. range		zone 2, 22
RedBin-P-5000	0...5.000 Pa	up to 50.000 Pa	1-stage adjustable switch-point in meas. range		zone 2, 22
RedBin-P-5000-2	0...5.000 Pa	up to 50.000 Pa	2-stage adjustable switch-point in meas. range		zone 2, 22

InBin-P-.. Differential pressure switch for safe area

Type	Measurement range	Safe overload	Setting range	Special feature	Installation module
InBin-P- 100	0... 100 Pa	up to 5.000 Pa	1-stage adjustable switch-point in meas. range	adjustable switch activation delay 0...240 s	safe area
InBin-P- 500	0... 500 Pa	up to 5.000 Pa	1-stage adjustable switch-point in meas. range		safe area
InBin-P- 500-2	0... 500 Pa	up to 5.000 Pa	2-stage adjustable switch-point in meas. range		safe area
InBin-P-5000	0...5.000 Pa	up to 50.000 Pa	1-stage adjustable switch-point in meas. range		safe area
InBin-P-5000-2	0...5.000 Pa	up to 50.000 Pa	2-stage adjustable switch-point in meas. range		safe area

Accessories

Type	Description/Technical data
Kit 2	Includes 2 meter pressure hose (inner diameter 6 mm) and 2 plastic fittings
MKR-VA/AL	Mounting bracket for installation on round air-ducts (diameter up to 600 mm)

Special options and offshore kits see page 52

Pressure, differential pressure (Filter/Fan belt monitoring) – switching

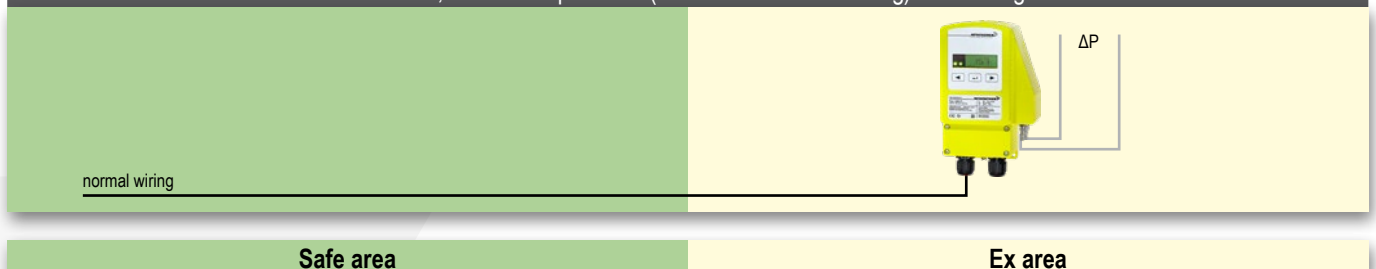



## ExBin-FR/RedBin-FR/InBin-FR Frost protection thermostats

Explosion proof		Industrial	Features ExBin-FR-..., RedBin-FR-..., InBin-FR-...	
<b>ExBin-FR-..</b> Zone 1, 2, 21, 22 Gas + Dust certified according to ATEX, IECEx, EAC	<b>RedBin-FR-..</b> Zone 2, 22 Gas + Dust certified according to ATEX, IECEx, EAC, CSA	<b>InBin-FR-..</b> NOT Explosion proof and only for use in safe area IP66	<b>Description</b> ExBin-FR-..., RedBin-FR-.. and InBin-FR-.. are frost protection thermostats for HVAC systems, e.g. for frost protection monitoring of heating registers/heat exchangers.	<b>Basics</b> <ul style="list-style-type: none"> <li>• No additional module in the panel required!</li> <li>• No intrinsically safe wiring required!</li> <li>• 24 VAC/DC supply</li> <li>• Temperature sensing by capillary with 3 m or 6 m length (depending on type)</li> <li>• Min. reaction length of capillary ~ 40 cm</li> <li>• 1 potential-free contact</li> <li>• Switch-point is adjustable mechanically</li> <li>• Switching status display with LED</li> <li>• Aluminium housing IP66</li> <li>• Integrated terminal box (ExBin-.. with "Ex-e")</li> <li>• Dimensions (H x W x D) 180 x 107 x 66 mm</li> </ul>
			<b>Delivery:</b> 1 Frost protection thermostat with integrated terminal box, with 3 m or 6 m capillary (depending on type), 3 tapping screws	
			<b>Recommended accessory:</b> for ..Bin-FR-3: Kit 1.3 for ..Bin-FR-6: Kit 1.6	

### ExBin-FR-.. frost protection thermostats for zone 1, 2, 21, 22

Type	Capillary	Temperature range	Setting range	Installation module
ExBin-FR-3	3 m	-10 ... +15 °C	1-stage adjustable switch-point in temperature range	zone 1, 2, 21, 22
ExBin-FR-6	6 m	-10 ... +15 °C	1-stage adjustable switch-point in temperature range	zone 1, 2, 21, 22

### RedBin-FR-.. frost protection thermostats for zone 2, 22

Type	Capillary	Temperature range	Setting range	Installation module
RedBin-FR-3	3 m	-10 ... +15 °C	1-stage adjustable switch-point in temperature range	zone 2, 22
RedBin-FR-6	6 m	-10 ... +15 °C	1-stage adjustable switch-point in temperature range	zone 2, 22

### InBin-FR-.. frost protection thermostats for safe area

Type	Capillary	Temperature range	Setting range	Installation module
InBin-FR-3	3 m	-10 ... +15 °C	1-stage adjustable switch-point in temperature range	safe area
InBin-FR-6	6 m	-10 ... +15 °C	1-stage adjustable switch-point in temperature range	safe area

### Accessories



Type	Description/Technical data
Kit 1.3	Capillary duct, assembly cramp and 4 assembly brackets for frost protection thermostat ..Bin-FR-3
Kit 1.6	Capillary duct, assembly cramp and 8 assembly brackets for frost protection thermostat ..Bin-FR-6
MKR-VA/AL	Mounting bracket for installation on round air-ducts (diameter up to 600 mm)

Special options and offshore kits see page 52

### Frost protection thermostat – switching

normal wiring	
Safe area	Ex area

## ExBin-A/RedBin-A/InBin-A Switching modules

Explosion proof			Industrial	Features of ExBin-A-.., RedBin-A-.., InBin-A-..	
<b>ExBin-A-..</b> Zone 1, 2, 21, 22 Gas + Dust certified according to ATEX, IECEx, EAC	<b>RedBin-A-..</b> Zone 2, 22 Gas + Dust certified according to ATEX, IECEx, EAC, CSA	<b>InBin-A-..</b> NOT Explosion proof and only for use in safe area IP66	<b>Description</b> ExBin-A-.., RedBin-A-.. and InBin-A-.. modules are switching modules for direct mounting in Ex areas (except InBin-A) with 1 or 2 channels, for connection of 1 or 2 passive, potential-free, switching sensors, for use in HVAC systems. <b>Delivery:</b> 1 module with sockets for 1 or 2 ExSens sensors (dependent on type), 3 tapping screws <b>Accessory (optional):</b> Binary sensors series ExSens, see next page	<b>Basics</b> <ul style="list-style-type: none"> <li>• No additional module in the panel required!</li> <li>• No intrinsically safe wiring required!</li> <li>• Mounting of module directly in Ex area</li> <li>• 24 VAC/DC supply</li> <li>• Sockets for 1 or 2 passive, potential-free, switching sensors</li> <li>• 1 or 2 contacts with common supply unit</li> <li>• 1 or 2 contacts with additional clamp for time switch relays, e.g. for 2 fan belt monitoring applications (time 120 sec.)</li> <li>• Switching status display with LED</li> <li>• Aluminium housing IP66</li> <li>• Integrated terminal box (ExBin.. with "Ex-e")</li> <li>• Dimensions (H × W × D) 180 × 107 × 66 mm</li> </ul>	
					

### ExBin-A-.. Switching modules for 1 or 2 passive switching sensors for zone 1, 2, 21, 22

Type	Description/Technical data	Installation module	Installation sensor*
ExBin-A-1	Module (1 channel) to connect 1 switching ExSens sensor in Ex area	zone 1, 2, 21, 22	zone 0, 1, 2, 20, 21, 22
ExBin-A-2	Module (2 channel) to connect 2 switching ExSens sensors in Ex area	zone 1, 2, 21, 22	zone 0, 1, 2, 20, 21, 22

\*in acc. with certification of sensor!

### RedBin-A-.. Switching modules for 1 or 2 passive switching sensors for zone 2, 22

Type	Description/Technical data	Installation module	Installation sensor*
RedBin-A-1	Module (1 channel) to connect 1 switching ExSens sensor in Ex area	zone 2, 22	zone 0, 1, 2, 20, 21, 22
RedBin-A-2	Module (2 channel) to connect 2 switching ExSens sensors in Ex area	zone 2, 22	zone 0, 1, 2, 20, 21, 22

\*in acc. with certification of sensor!

### InBin-A-.. Switching modules for 1 or 2 passive switching sensors for safe area

Type	Description/Technical data	Installation module	Installation sensor
InBin-A-1	Module (1 channel) to connect 1 switching sensor	safe area	safe area
InBin-A-2	Module (2 channel) to connect 2 switching sensors	safe area	safe area

### Accessories

Type	Description/Technical data
MKR-VA/L	Mounting bracket for installation on round air-ducts (diameter up to 600 mm)

Special options and offshore kits see page 52

### 1- or 2-channel switching module for passive switching sensors

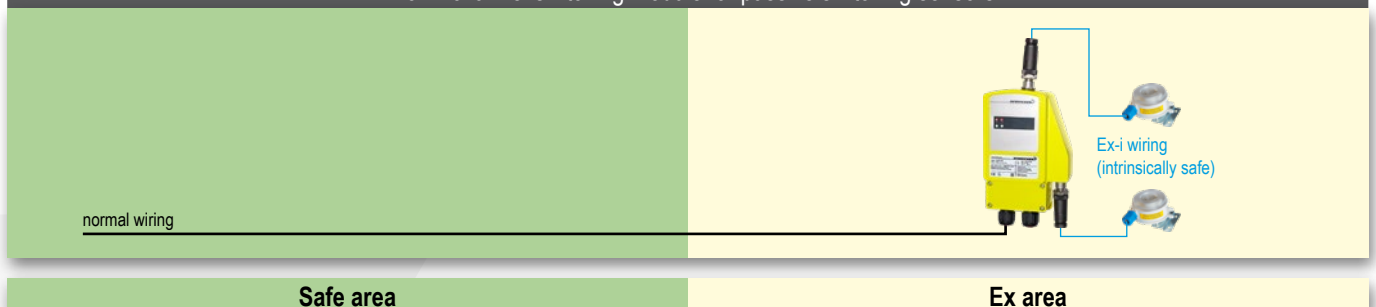

ExBin-D/RedBin-D/InBin-D Thermostats, hygrometers

Explosion proof		Industrial	Features of ExBin-D-..., RedBin-D-..., InBin-D-...	
<b>ExBin-D-..</b> Zone 1, 2, 21, 22 Gas + Dust certified according to ATEX, IECEx, EAC	<b>RedBin-D-..</b> Zone 2, 22 Gas + Dust certified according to ATEX, IECEx, EAC, CSA	<b>InBin-D-..</b> NOT Explosion proof and only for use in safe area IP66	<b>Description</b> ExBin-D-..., RedBin-D-... and InBin-D-... modules are used together with ExPro- B-../InPro-B-.. sensors as thermostats or hygrometers in HVAC systems.  <b>Delivery:</b> 1 Ex/Red/InBin-.. module with socket for 1 ExPro-B-../InPro-B-.. sensor, 3 tapping screws  <b>Required accessory (additional price):</b> ExPro-B-.. or InPro-B-.. sensor  <b>Ordering example</b> for one thermostat in an air duct, 150 mm sensor length, with sensor in Ex zone 21.  <b>Types to order:</b> 1 × ExBin-D-.. 1 × ExPro-BT150 (Ex-i sensor)	<b>Basics</b> <ul style="list-style-type: none"> <li>• No additional module in the panel required!</li> <li>• No intrinsically safe wiring required!</li> <li>• 24 VAC/DC supply</li> <li>• Socket for ExPro-B-.. sensor</li> <li>• Selectable on site if used for room or duct application</li> <li>• Switch-point for °C and %rH separately adjustable (dependent on sensor type)</li> <li>• 1-channel: 2 pot.-free contacts (1 × °C, 1 × %rH)</li> <li>• 2-channel: 4 pot.-free contacts (2 × °C, 2 × %rH)</li> <li>• Display with indication of actual value</li> <li>• Switching status display with LED</li> <li>• Aluminium housing IP66</li> <li>• Integrated terminal box (ExBin-.. with "Ex-e")</li> <li>• Dimensions (H × W × D) 180 × 107 × 66 mm</li> </ul>

ExBin-D-.. thermostats and/or hygrometers, dependent on sensor type ExPro-B-.. for zone 1, 2, 21, 22

Type	Description/Technical data	Installation module	Installation ExPro-B-.. sensor
ExBin-D	Module for connection of one ExPro-B-.. sensor as thermostat and/or hygrometer, 1-stage	zone 1, 2, 21, 22	zone 1, 2, 21, 22
ExBin-D-2	Module for connection of one ExPro-B-.. sensor as thermostat and/or hygrometer, 2-stage	zone 1, 2, 21, 22	zone 1, 2, 21, 22

RedBin-D-.. thermostats and/or hygrometers, dependent on sensor type ExPro-B-.. for zone 2, 22

Type	Description/Technical data	Installation module	Installation ExPro-B-.. sensor
RedBin-D	Module for connection of one ExPro-B-.. sensor as thermostat and/or hygrometer, 1-stage	zone 2, 22	zone 1, 2, 21, 22
RedBin-D-2	Module for connection of one ExPro-B-.. sensor as thermostat and/or hygrometer, 2-stage	zone 2, 22	zone 1, 2, 21, 22

InBin-D-.. thermostats and/or hygrometers, dependent on sensor type InPro-B-.. for safe area

Type	Description/Technical data	Installation module	Installation InPro-B-.. sensor
InBin-D	Module for connection of one InPro-B-.. sensor as thermostat and/or hygrometer, 1-stage	safe area	safe area
InBin-D-2	Module for connection of one InPro-B-.. sensor as thermostat and/or hygrometer, 2-stage	safe area	safe area

Accessories

Type	Description/Technical data
MKR-VA/JAL	Mounting bracket for installation on round air-ducts (diameter up to 600 mm)

Special options and offshore kits see page 52

Example of combinations

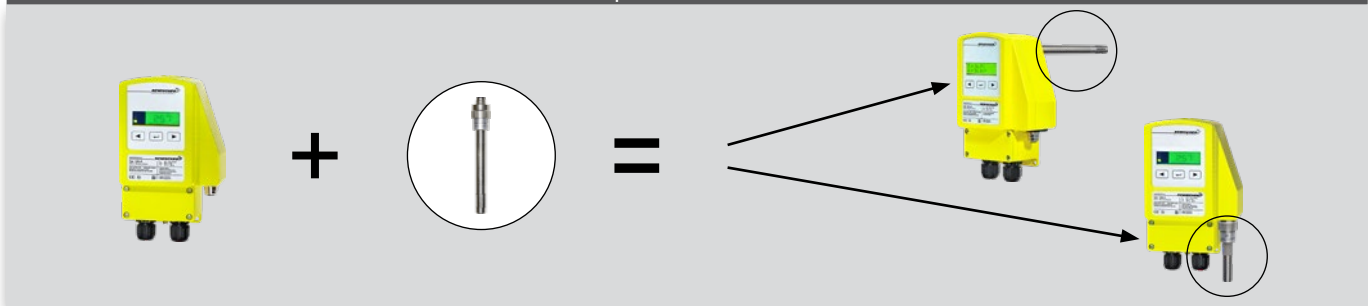

## ExPro-B.../InPro-B... Thermostat/hygrostat sensors

### Explosion proof

### Industrial

### Features of ExPro-B..., InPro-B...

#### ExPro-B...

Zone 1, 2, 21, 22  
Gas + Dust  
EC type-approved  
with ExBin-D-/RedBin-D  
modules



#### InPro-B...

Only for use with  
InBin-D.. transmitter!  
**NOT** for use in  
Ex area!



#### Description

ExPro-B... sensors are used for measurements of temperature and/or humidity in hazardous locations, for **exclusive** use with ExBin-D... / RedBin-D... modules!

InPro-B... sensors are suitable for temperature and/or humidity measurement in safe areas, for **exclusive** use with InBin-D... modules!

**Delivery:** 1 sensor with connector

**Example:** room-humidity sensor, 50 mm length

**Type:** 1 × ExPro-BF-50

**Attention:** only in combination with:  
1 × ExBin-D... or RedBin-D...  
(InBin-D... with InPro-B... sensors)

#### Basics

- Sensors for connection to ExBin-D..., RedBin-D..., InBin-D... modules. Adaption via connector
- ExPro-B.../InPro-B... sensors can be optionally screwed to the housing at the back (duct measurement) or bottom (room measurement)
- When using humidity-sensors, the contamination and aggressiveness of the medium has to be regarded

## Sensors for ExBin-D... and RedBin-D... modules

Type	Function	Measurement range	Sensor length	Main use	Connectable to	Installation area
ExPro-BT - 50	Thermostat	-40...+ 80 °C	50 mm	Room/Duct	ExBin-D RedBin-D	zone 1, 2, 21, 22
ExPro-BT - 100	Thermostat	-40...+ 125 °C	100 mm	Duct	ExBin-D RedBin-D	zone 1, 2, 21, 22
ExPro-BT - 150	Thermostat	-40...+ 125 °C	150 mm	Duct	ExBin-D RedBin-D	zone 1, 2, 21, 22
ExPro-BT - 200	Thermostat	-40...+ 125 °C	200 mm	Duct	ExBin-D RedBin-D	zone 1, 2, 21, 22
ExPro-BF - 50	Hygrostat	0...100 %rH	50 mm	Room/Duct	ExBin-D RedBin-D	zone 1, 2, 21, 22
ExPro-BF - 100	Hygrostat	0...100 %rH	100 mm	Duct	ExBin-D RedBin-D	zone 1, 2, 21, 22
ExPro-BF - 150	Hygrostat	0...100 %rH	150 mm	Duct	ExBin-D RedBin-D	zone 1, 2, 21, 22
ExPro-BF - 200	Hygrostat	0...100 %rH	200 mm	Duct	ExBin-D RedBin-D	zone 1, 2, 21, 22
ExPro-BTF- 50	Combination Thermostat/Hygrostat	-40...+ 80 °C, 0...100 %rH	50 mm	Room/Duct	ExBin-D RedBin-D	zone 1, 2, 21, 22
ExPro-BTF-100	Combination Thermostat/Hygrostat	-40...+ 125 °C, 0...100 %rH	100 mm	Duct	ExBin-D RedBin-D	zone 1, 2, 21, 22
ExPro-BTF-150	Combination Thermostat/Hygrostat	-40...+ 125 °C, 0...100 %rH	150 mm	Duct	ExBin-D RedBin-D	zone 1, 2, 21, 22
ExPro-BTF-200	Combination Thermostat/Hygrostat	-40...+ 125 °C, 0...100 %rH	200 mm	Duct	ExBin-D RedBin-D	zone 1, 2, 21, 22

## Sensors for InBin-D... modules

Type	Function	Measurement range	Sensor length	Main use	Connectable to	Installation area
InPro-BT - 50	Thermostat	-40...+ 80 °C	50 mm	Room/Duct	InBin-D	safe area
InPro-BT - 100	Thermostat	-40...+ 125 °C	100 mm	Duct	InBin-D	safe area
InPro-BT - 150	Thermostat	-40...+ 125 °C	150 mm	Duct	InBin-D	safe area
InPro-BT - 200	Thermostat	-40...+ 125 °C	200 mm	Duct	InBin-D	safe area
InPro-BF - 50	Hygrostat	0...100 %rH	50 mm	Room/Duct	InBin-D	safe area
InPro-BF - 100	Hygrostat	0...100 %rH	100 mm	Duct	InBin-D	safe area
InPro-BF - 150	Hygrostat	0...100 %rH	150 mm	Duct	InBin-D	safe area
InPro-BF - 200	Hygrostat	0...100 %rH	200 mm	Duct	InBin-D	safe area
InPro-BTF- 50	Combination Thermostat/Hygrostat	-40...+ 80 °C, 0...100 %rH	50 mm	Room/Duct	InBin-D	safe area
InPro-BTF-100	Combination Thermostat/Hygrostat	-40...+ 125 °C, 0...100 %rH	100 mm	Duct	InBin-D	safe area
InPro-BTF-150	Combination Thermostat/Hygrostat	-40...+ 125 °C, 0...100 %rH	150 mm	Duct	InBin-D	safe area
InPro-BTF-200	Combination Thermostat/Hygrostat	-40...+ 125 °C, 0...100 %rH	200 mm	Duct	InBin-D	safe area



## Accessories

Type	Description/Technical data
MFK	Mounting flange for duct-installation, for variable depth of immersion in the air duct
TH- VA	Probe made of stainless-steel V4A 1.4571, length 150 mm for ..Pro-BT-200. Other lengths on request
Kit-FA-VA	Sinter filter cap for humidity sensor (only up to 90 %rH)
MKR-VA/AL	Mounting bracket for installation on round air-ducts (diameter up to 600 mm)

**ExLine Ex-switching module for potential free, binary signals in zone 0, 1, 2, 20, 21, 22**

Explosion proof

Features EXL-IR-9170-11-12-11s C2304 SV

EXL-IR-9170-..	EXL-IR-9170-..	Description	Basics
Zone 0, 1, 2, 20, 21, 22 Gas + Dust certified according to ATEX, IECEx, CSA, FM/UL, EAC, INMETRO, KOSHA 	 	Module with intrinsically safe circuit to change a passive potential free binary signal (e.g. contact) into a contact in the safe area. Module must be installed in the safe area, sensor in the hazardous location!  <b>Delivery:</b> 1 Ex-i module for DIN rail mounting  <b>Accessory (optional):</b> binary sensors type ExSens	<ul style="list-style-type: none"> <li>• 24 V DC supply</li> <li>• Inverse-polarity protection</li> <li>• Input: passive potential free binary sensor</li> <li>• Output: potential free contact in the safe area</li> <li>• LED operation indication</li> <li>• Applicable up to SIL 2</li> <li>• Dimensions (W × H × D) 17,6 × 99 × 114,5 mm</li> <li>• Rail mounting according DIN</li> <li>• Installation in safe area</li> </ul>

**EXL-IR-9170-11-12-11s C2304 SV switching module**

Type	Description/Technical data	Installation module	Installation sensor*
EXL-IR-9170-..	1 module (rail mounting) for 1 passive binary sensor series ExSens	safe area	zone 0, 1, 2, 20, 21, 22
<b>Optional:</b>			
<b>N1 supply unit</b>	Input 120...240 VAC, output 24 VDC, max. 0,5 A, max. 4 pcs. EXL-IR-.. connectable. N1 supply unit is required only in case of 120...240 VAC supply!		

\*in acc. with certification of sensor!



## ExSens passive, switching sensors for zone 1, 2, 22

Explosion proof

Features ExSens

**ExSens**

Zone 1, 2, 22  
Gas + Dust  
certified according to  
ATEX  
Manufacturer certificate

**passive, switching**



**Description**

ExSens switching sensors for temperature, humidity or pressure measurement in hazardous locations with manufacturer certification in acc. with ATEX. The sensors are passive and potential free.

**Delivery:** 1 Sensor  
**Ordering example** for 1 frost protection thermostat  
**Type to purchase:** 1 × TBK-FR-2G

**Basics**

- Sensors for installation in hazardous locations, connected to a switching module type ExBin-A-..., RedBin-A-... or EXL-IR-9170-...
- The module changes the passive binary signal into a contact in safe area
- Standard sensor design with integrated scale and adjustment
- Sensor is installed in the hazardous location, module in the safe area

### Sensors, connectable to switching modules type ExBin-A-..., RedBin-A-..., EXL-IR-9170-...

Type	Function	Range	Sensor	Information	Connectable to module type	Sensor in zone
TBR -2G	Room thermostat	0...+40 °C, 1 K	Contact, 2-pos		ExBin-A-..., RedBin-A-..., EXL-IR-...	1, 2
TBR -2G3D	Room thermostat (IP65)	-35...+30 °C, 2-20 K	Contact, 2-pos		ExBin-A-..., RedBin-A-..., EXL-IR-...	1, 2, 22
TBR-2 -2G	Room thermostat 2 stage	0...+60 °C, 1 K	2 × Contact, 2-pos		2 × ExBin-A-..., RedBin-A-..., EXL-IR-...	1, 2
TBR-AN-2G	Room temperature direct contact	0...+60 °C, 5 ± 1 K (fix)	Contact, 2-pos		ExBin-A-..., RedBin-A-..., EXL-IR-...	1, 2
TBK -2G	Duct thermostat (IP65)	0...+65 °C, 2-20 K	Contact, 2-pos		ExBin-A-..., RedBin-A-..., EXL-IR-...	1, 2
TBT -2G	Sensor thermostat (IP54)	0...+90 °C, 3 K	Contact, 2-pos	L = 120 mm	ExBin-A-..., RedBin-A-..., EXL-IR-...	1, 2
TBT-VA -2G	Sensor thermostat with VA sleeve	0...+90 °C, 3 K	Contact, 2-pos	V4A	ExBin-A-..., RedBin-A-..., EXL-IR-...	1, 2
TBK-FR-2G	Frost protection thermostat (IP65)	-10...+12 °C	Contact, 2-pos	capillary 6 m	ExBin-A-..., RedBin-A-..., EXL-IR-...	1, 2
FBR -2G	Room hygostat	35...100 %rH, ~ 4 %rH	Contact, 2-pos		ExBin-A-..., RedBin-A-..., EXL-IR-...	1, 2
FBK -2G	Duct hygostat	35...100 %rH, ~ 4 %rH	Contact, 2-pos	L = 180 mm	ExBin-A-..., RedBin-A-..., EXL-IR-...	1, 2
DBK -2G	Differential pressure	20-300, 50-500, 100-1.000 Pa	Contact, 2-pos		ExBin-A-..., RedBin-A-..., EXL-IR-...	1, 2
DBK -2G3D	Differential pressure (IP65)	40-125, 100-400, 350-1.400 Pa	Contact, 2-pos		ExBin-A-..., RedBin-A-..., EXL-IR-...	1, 2, 22
LGW-2G-...-SIL	Differential pressure	0,04-0,3/0,1-1/0,25-5/3-15 kPa	Contact, single	SIL		EXL-IR-... 1, 2
WFBK -2G	Air paddle	2...8 m/s, paddle V2A	Contact, 2-pos		ExBin-A-..., RedBin-A-..., EXL-IR-...	1, 2
SWBT -2G	liquid flow switch	-20...+60 °C	Contact, 2-pos		ExBin-A-..., RedBin-A-..., EXL-IR-...	1, 2
NBW-K -2G	Fan belt protection (IP65)	up to < 20.000 m³/h	Namur sensor + bracket		ExBin-A-..., RedBin-A-..., EXL-IR-...	1, 2
NBW-G -2G	Fan belt protection (IP65)	more than > 20.000 m³/h	Namur sensor + bracket		ExBin-A-..., RedBin-A-..., EXL-IR-...	1, 2

NEW

### Accessories

Type	Description/Technical data
Installation-Kit-1	for frost protection sensor type TBK-FR-2G, PG entries for capillary, 6 brackets, support bracket
Install-Kit-2-DBK	includes 2 meter pressure hose (inner diameter Ø 6 mm) 2 plastic fittings

**..VA/..CT Special options for sensors – overview**

Overview of special options of Schischek sensors for use under extreme weather conditions

**Application area:**

Usage in hazardous locations under extreme weather conditions and/or for offshore/onshore applications.

**Advantages:**

- Resistant against corrosive and/or maritime atmosphere
- Usage under extreme weather conditions
- Approved for offshore-/onshore applications
- Robust and thereby extended period of application time of sensors

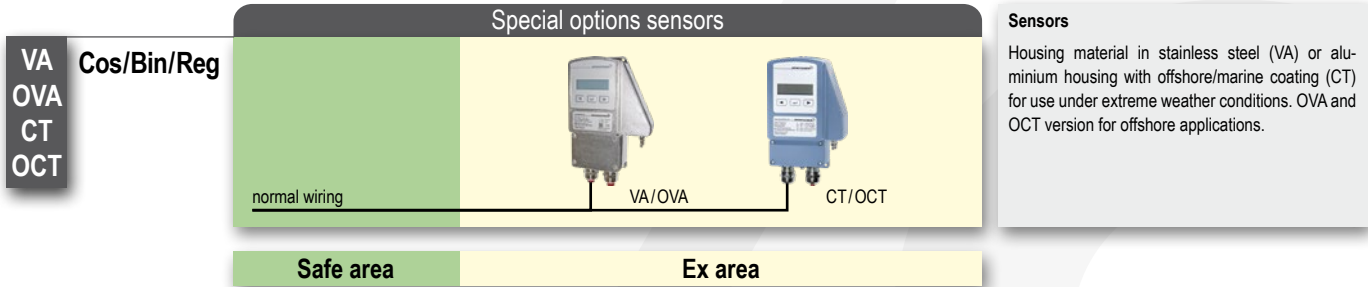

**..Cos/..Bin/..Reg Special options for sensors**

Explosion proof

Features ..Cos/..Bin/..Reg-...-VA/OVA/CT/OCT

Cos/Bin/Reg-...-VA/CT	Special options	Description	Basics
available for all sensors In accordance with type for use in Ex area or safe area		<p>VA version with housing material in stainless steel similar AISI 316, some parts nickel plated.</p> <p>OVA version also with stainless steel housing but suitable especially for offshore applications.</p> <p>CT version with aluminium housing and offshore/marine coating, resistant against corrosive and maritime atmosphere, some parts nickel plated.</p> <p>OCT version with painted housing like CT, but suitable especially for offshore applications.</p> <p><b>Delivery:</b> 1 sensor with special option</p> <p><b>Ordering example:</b> ExCos-P-250-CT</p>	<p><b>VA:</b></p> <ul style="list-style-type: none"> <li>• Housing material in stainless steel similar AISI 316, some parts nickel plated, resistant against corrosive/maritime atmosphere, screws in stainless steel</li> </ul> <p><b>OVA:</b></p> <ul style="list-style-type: none"> <li>• Basics like VA, but offered as offshore version with additionally tubes for clamping ring Ø 6 mm in stainless steel</li> </ul> <p><b>CT:</b></p> <ul style="list-style-type: none"> <li>• offshore/marine coated aluminium housing, resistant against corrosive/maritime atmosphere</li> <li>• Cable glands brass nickel plated, screws in stainless steel</li> </ul> <p><b>OCT:</b></p> <ul style="list-style-type: none"> <li>• Basics like CT, but offered as offshore version with M20 cable glands and additionally with tubes for clamping ring Ø 6 mm in stainless steel</li> </ul> <p><b>For general basics see description of Cos/Bin/Reg.</b></p>

**..Cos/..Bin/..Reg.. options**

Type	Description/Technical data
Cos/Bin/Reg-...-VA	Housing material in stainless steel similar AISI 316, some parts nickel plated, screws in stainless steel (surcharge)
Cos-P/Bin-P/Reg-V...-OVA	Offshore version with seawater resistant stainless steel housing. M20 cable glands Ni-plated, pressure connection tubes and screws in stainless steel (surcharge)
Cos/Bin/Reg-...-CT	Offshore/marine coated aluminium housing, resistant against corrosive and/or maritime atmosphere. Cable glands Ni-plated, screws in stainless steel (surcharge)
Cos-P/Bin-P/Reg-V...-OCT	Offshore version with seawater resistant offshore/marine coated Al-housing. M20 cable glands Ni-plated, pressure connection tubes and screws in stainless steel (surcharge)
Kit-S8-	CBR Cable glands 2 x M16 x 1,5 mm Ex-e (for cables Ø 5-10 mm) in brass nickel plated for replace the plastic cable glands of ..Cos/..Bin/..Reg sensors
Kit-Offs-GL-CBR	Cable glands 2 x M20 x 1,5 mm Ex-d in brass nickel plated for armoured cables suitable for ..Cos/..Bin/..Reg sensors
Kit-PTC-	CBR Pressure tube connection in stainless steel 316 L for 6 mm clamp fittings

## ExPolar Heating system – overview

Overview of new heating system for use with Schischek sensors down to -40 °C

**Application area:**

Usage in hazardous locations for temperatures down to -40 °C.

**Advantages:**

- Especially for usage under high sub-zero temperatures (down to -40 °C)
- Usage directly in hazardous locations
- Adaptable on all Schischek sensors

°C ExPolar...-CBR



Heating system for sensors

normal wiring



**ExPolar...-CBR**

Adaptable on Schischek sensors type ExCos..., ExBin..., ExReg...

Safe area

Ex area

## ExPolar/InPolar Heating system for ..Cos-../Bin-../Reg-.. sensors

Explosion proof	Industrial	Features ..Polar-...-CBR	
<p><b>ExPolar-...-CBR</b></p> <p>Zone 1, 2, 21, 22 Gas + Dust certified according to ATEX, IECEx, EAC</p> 	<p><b>InPolar-...-CBR</b></p> <p>NOT explosion proof and only for use in safe area IP66</p> 	<p><b>Description</b></p> <p>Controlled heating system for use in sub-zero regions down to -40 °C. Adaptable on Schischek sensors ..Cos-..., ..Bin-... or ..Reg-...</p> <p><b>Delivery:</b> 1 heating system (adaptable)</p> <p><b>Ordering example:</b> ExPolar-240-CBR</p>	<p><b>Basics</b></p> <ul style="list-style-type: none"> <li>• 24/48 VAC/DC, 120/240 VAC</li> <li>• 60 W</li> <li>• -40 °C... +60 °C</li> <li>• ExPolar for zone 1, 2, 21, 22</li> <li>• InPolar for safe area</li> </ul>

### ExPolar-...-CBR/InPolar-...-CBR

Type	Adaptable on	Operation temperature	Supply	Power*	Installation area
ExPolar-...-CBR	ExCos-../ExBin-../ExReg-..	-40 °C up to +60 °C	24 VAC/DC 48 VAC/DC 120 VAC 240 VAC	60 W	zone 1, 2, 21, 22
InPolar-...-CBR	InCos-../InBin-../InReg-..	-40 °C up to +60 °C	24 VAC/DC 48 VAC/DC 120 VAC 240 VAC	60 W	safe area

↑ Supply voltage



\*Nominal value

Not suitable for VA versions!

### Special option

Type	Description/Technical data	
...Polar-...-CT	Housing offshore/marine coated, resistant against corrosive/maritime atmosphere, some parts nickel plated	(surcharge)

## ExArctic/InArctic Heating system for ..Cos-../Bin-../Reg-.. sensors NEW

Explosion proof	Industrial	Features ..Arctic-..	
<p><b>ExArctic-CBR</b></p> <p>Hazardous Location</p>  <p>Schematic visualisation </p>	<p><b>InArctic-CBR</b></p> <p>Safe Area</p>  <p>Schematic visualisation</p>	<p><b>Description</b></p> <p>Controlled heating system with protective housing for use down to -60 °C. Suitable for Schischek sensors ..Cos-..., ..Bin-... or ..Reg-...</p> <p><b>Delivery:</b> 1 heating system 1 protective housing 1 mounting material set</p>	<p><b>Basics</b></p> <ul style="list-style-type: none"> <li>• -60 °C</li> <li>• ExArctic for hazardous locations</li> <li>• InArctic for safe area</li> <li>• details and prices on request</li> <li>• subject to change</li> </ul>

## ExMag Electric door holder magnets according ATEX for zone 1, 2, 21, 22

Explosion proof		Features ExMag (EXM)	
<b>ExMag</b> Zone 1, 2, 21, 22 Gas + Dust certified according to ATEX, IECEx DNV-GL	<b>Magnet</b> 	<b>Description</b> ExMag door holder magnets are electric magnets to keep doors open or closed as long as supply voltage is available.  <b>Delivery:</b> 1 magnet <b>Ordering example:</b> 650 N magnet + anchor + Ex-terminal box <b>Type to purchase:</b> 1 × EXM-650 + 1 GH 6 + 1 × EXC-K4/S	<b>Basics</b> <ul style="list-style-type: none"> <li>• Electric magnets, silicone free</li> <li>• Force in acc. with type</li> <li>• 24 VDC power supply</li> <li>• 1 m cable, silicone and halogen free</li> <li>• Ex-e terminal box is required for electrical connection</li> <li>• The max. AC-ripple must not exceed 20%</li> </ul>

### Ex-m ExMag magnets

Type	Force	Supply	Function	Current	Installation in
EXM- 650	650 N	24 VDC	Magnet	44 mA	Zone 1, 2, 21, 22
EXM-1300	1.300 N	24 VDC	Magnet	65 mA	Zone 1, 2, 21, 22
EXM-2000	2.000 N	24 VDC	Magnet	160 mA	Zone 1, 2, 21, 22

### Accessories

Type	Description/Technical data
GH-6	Anchor for EXM-650
GH-13/20	Anchor for EXM-1300 and EXM-2000
ExBox-3P	Ex-e terminal box, IP66
EXC-K4/S	Ex-e terminal box, IP66, with integrated fuse
EXC-T1	Ex-d push button
N1 supply unit	Input 120...240 VAC, output 24 VDC, max. 0,5 A

## ExComp different Ex-components

Explosion proof		Features ExComp (EXC...)	
<b>ExComp</b> Zone 1, 2, 21, 22 (in acc. to type) Gas + Dust certified according to ATEX	<b>Components</b> 	<b>Description</b> Different explosion proof products like switches, safety temperature sensors, ....  <b>Delivery:</b> 1 component <b>Ordering example:</b> Switch 20 A, 6 pole <b>Type to purchase:</b> 1 × EXC-R 20/6	<b>Basics</b> <ul style="list-style-type: none"> <li>• No specific information</li> <li>• Data in acc. with every single product / type</li> </ul>

### ExComp components

Type	Application	Explosion proof	Technical data
EXC-R 10/3...	Switch	II2G EEx ed IIC T6	10 A - 240/400 V - 2,5/4,6 KW - 3 pole
EXC-R 20/3...	Switch	II2G EEx ed IIC T6	20 A - 240/400 V - 4,5/9,0 KW - 3 pole
EXC-R 20/6...	Switch	II2G EEx ed IIC T6	20 A - 240/400 V - 4,5/9,0 KW - 6 pole
EXC-R 40/3...	Switch	II2G EEx ed IIC T6	40 A - 240/400 V - 11/20 KW - 3 pole
EXC-R 40/6...	Switch	II2G EEx ed IIC T6	40 A - 240/400 V - 11/20 KW - 6 pole
EXC-DS1/VA	Safety temperature sensor	II2G EEx d IIC T6	Duct mounting, potential free contact, switching at 70°C...160°C (10°C steps)

## Content overview

Additional information	Page
Product codes/definitions	56-57
Installation according to ATEX (Zone system)	58
Installation according to NEC 500 (Division system, North America)	59
Valve automation	60-61
Certification information	62-63
Information about ATEX directives	64
Labelling of explosion proof equipment according to ATEX	65
Explosion proof information	66
Information about zones, explosion groups and temperature classes	67
Ex applications	68-71
Rotork products (extraction) and service	72-77
Damper actuation focused	78-79



Product codes/definitions

Description ..Max quarter turn actuators

**Ex Max - 5.10 - SF**

- S = integrated auxiliary **switches**, switching at 5° and 85°
- F = **spring return** (german word for spring is "Feder")
- Y = **modulating** actuator 0...10 VDC or 4...20 mA and feedback signal
- BF = **fire damper actuator**, intrinsically safe input for direct ExPro-TT connection (fire trigger)
- F1/F3 = actuator with **fast spring return** (number after letter F shows closing time in seconds, e.g. in ~ 1 or 3 seconds)
- C = **actuator for direct communication with Ex/InReg controller**

The numbers show the **torque in Nm**  
Two numbers mean that the **torque is selectable** on site (e.g. 5 or 10 Nm)

**Max** is a **rotary (quarter turn) actuator** for dampers or rotary valves, such as ball or butterfly valves

**Ex** is for use in **zone 1, 2, 21, 22**  
**Red** is for use in **zone 2, 22**  
**In** is for use in non classified **industrial** areas



Description ..Run valve actuators

**Red Run - 5.10 - Y**

- Y = **modulating** actuator 0...10 VDC or 4...20 mA and feedback signal
- U = **floating control** on/off, 3 pos. actuator with 0...10 VDC or 4...20 mA feedback signal

The numbers show the **force in N**  
Two numbers mean that the **force is selectable** on site (e.g. 500 or 1000 N)

**Run** is a **linear actuator** for globe style control valves with a stroke between 5 and 60 mm

**Ex** is for use in **zone 1, 2, 21, 22**  
**Red** is for use in **zone 2, 22**  
**In** is for use in non classified **industrial** areas



Description ..Cos analog transmitter

**In Cos - P - 2500**

The number shows the measuring range of the differential pressure sensor in  $\pm$  Pa

- P = **differential pressure sensor**
- D = module for **temperature/humidity** for connection of ExPro-C.. sensors

**Cos analog** transmitter with output 0...10 V or 4...20 mA

**Ex** is for use in **zone 1, 2, 21, 22**  
**Red** is for use in **zone 2, 22**  
**In** is for use in non classified **industrial** areas



Product codes / definitions

Description ..Bin binary sensors

**Ex Bin - P - 500 - 2**

Ex

Bin

P

500

2

The number stands for a **2-stage adjustable switch-point** in measurement range  
Without number the sensor comes with 1-stage, adjustable switch-point in measurement range

The number shows the max. adjustment range of the differential pressure switch in Pa

- P = differential pressure switch
- D = thermostat-/hygrostat modul for connection of ExPro-B.. sensors
- FR = frost protection thermostat
- A1 = switching module for connection of **one passive switch**
- A2 = switching module for connection of **two passive switches**

Bin switching measuring module with output as a potential free contact (1 opener or 1 closer)

Ex is for use in zone 1, 2 , 21, 22

Red is for use in zone 2, 22

In is for use in non classified industrial areas



Description ..Pro.. sensors for ..Cos-D or ..Bin-D modules

**Ex Pro - CTF - 200**

Ex

Pro

CTF

200

The number shows the **length** of the sensor in mm

- T = temperature sensor
- F = humidity sensor
- TF = combisensor temperature/humidity
- C = sensor for connection to Ex/Red/InCos-D
- B = sensor for connection to Ex/Red/InBin-D

Pro.. sensor for connection

Ex is for use in zone 1, 2 , 21, 22

In is for use in non classified industrial areas



Description ..Reg controller

**Ex Reg - V - 300 - A**

Ex

Reg

V

300

A

A = Type with **analog** signals for external communication

The number shows the control range of the controller in Pa (V-type only)

- V = volume flow control/pressure control
- D = temperature/humidity control

Reg controller

Ex is for use in zone 1, 2 , 21, 22

In is for use in non classified industrial areas



## Installation according to ATEX (Zone system)

### Installation zones

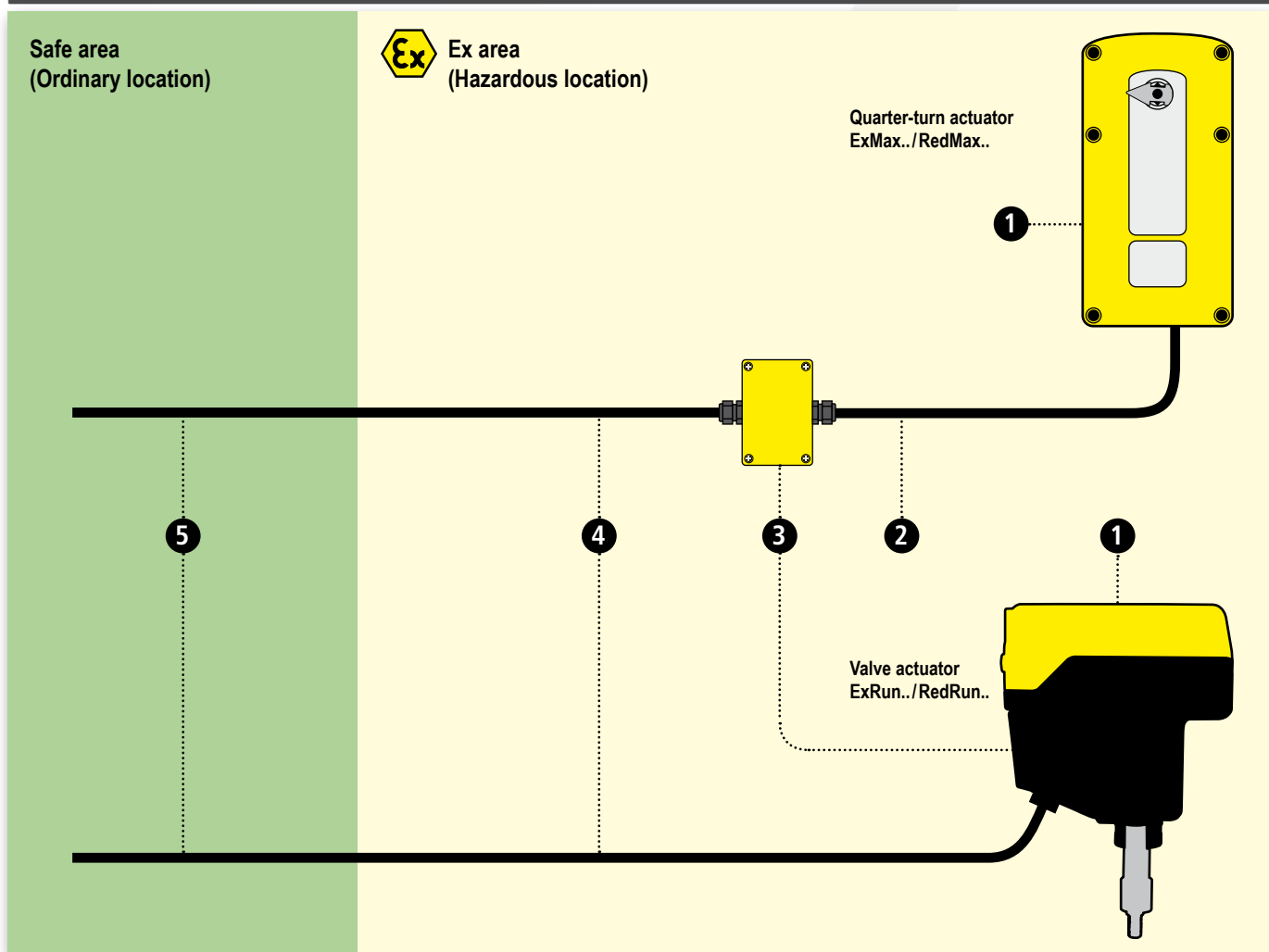

- ❶ Explosion proof actuator (ExMax/RedMax, ExRun/RedRun)
- ❷ Supply cable approximate ~ 1 m (39.4")
- ❸ Junction box in increased safety Ex-e technology

- ❹ Supply or control cable
- ❺ Supply or control cable reaches into the safe area...

Installation according to NEC 500 (Division system, North America)

Installation FM/CSA Div. classes

Safe area  
(Ordinary location)

**Ex** Ex area  
(Hazardous location)

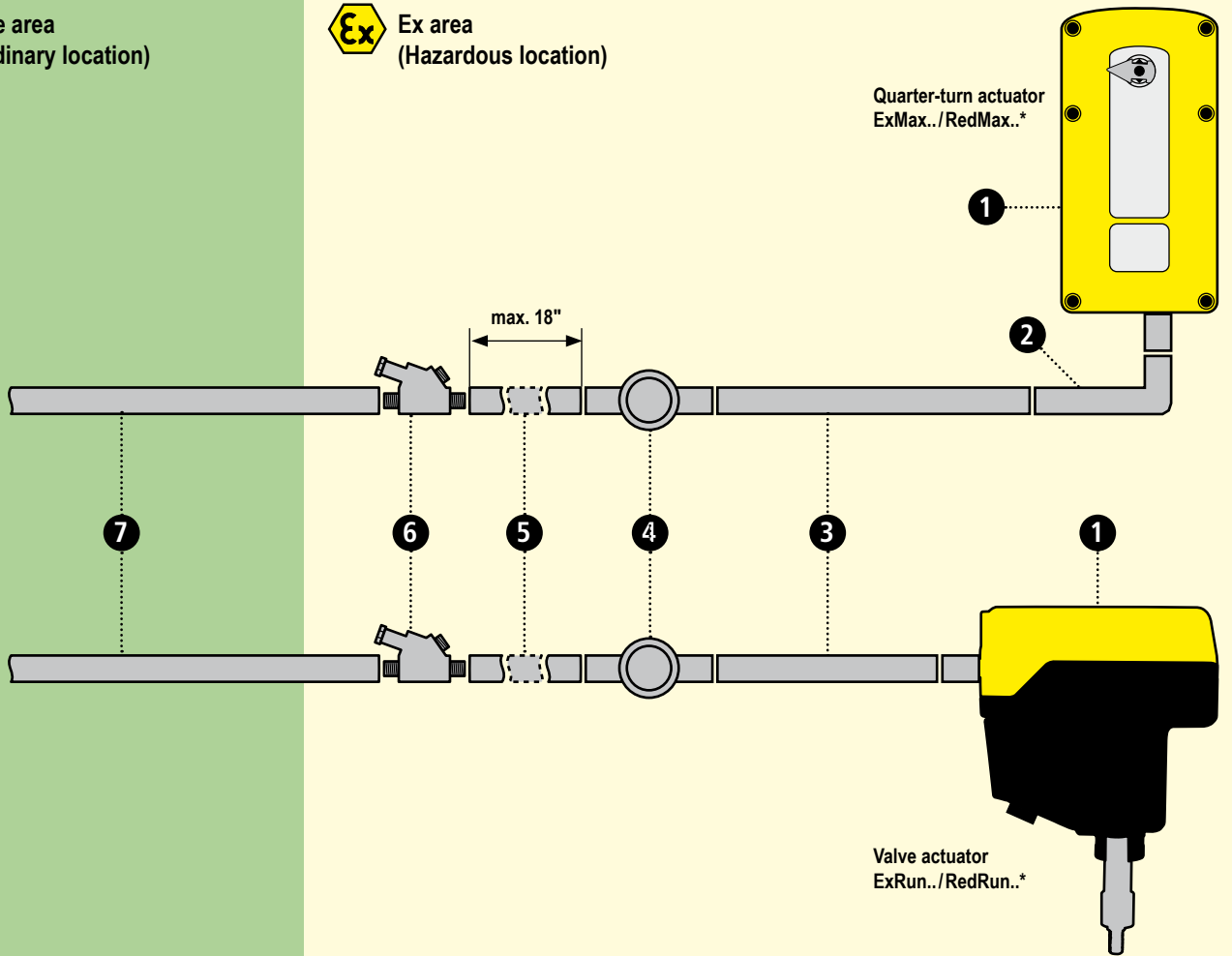

- ❶ Explosion proof actuator (ExMax/RedMax, ExRun/RedRun)
- ❷ Elbow device ...
- ❸ Connecting device ...
- ❹ Conduit box ...

- ❺ Connecting device, max. length 0,46 m (18")
- ❻ Seal fitting for horizontal or vertical conduits ...
- ❼ Connecting device reaches into the safe area ...

\* Variants for North America on request!

### Valve automation

#### Quarter-turn actuators

**..Max**  
¼-turn actuator

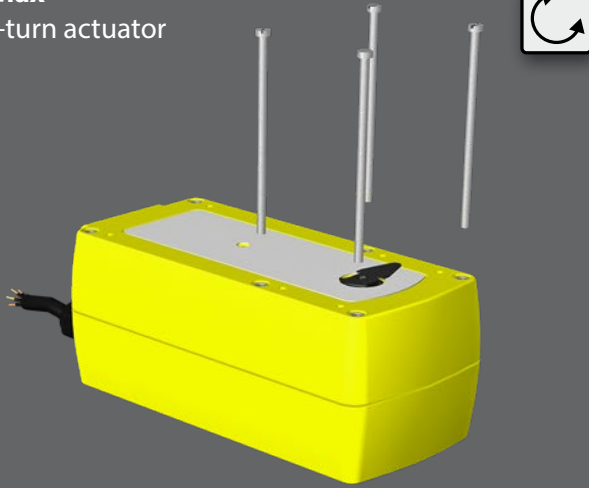

**Valve linkage**  
example

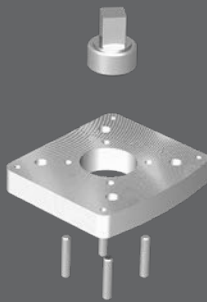

**Valve**  
example



#### Linear motion actuators

**..Run**  
Linear actuator



**Valve linkage**  
example



**Valve**  
example

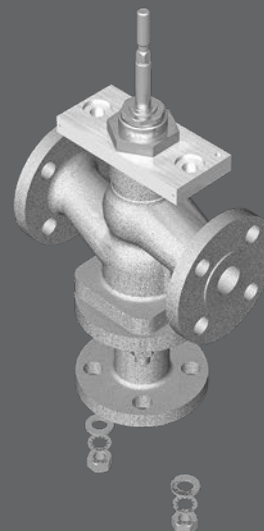

Valve automation

Schischek valve linkages

Option 1

You make the linkage yourself or source it somewhere else. In that case we would be happy to provide you with all the actuator dimensions necessary to do so. We can even give you STEP files you can import directly into your CAD system.

Title		ExMax 5.10-Y / 15.30-Y	
Dimensions			
List of parts	Project	Actuator	Signed
Substitute for	Actuator	ExMax	Checked
Origin	Origin		Approved
Schischek GmbH Mühling 45 Gewerbegebiet Süd 5 D-90579 Langenzem		Drawing No.	Rev
		090.0000.A4_Dimensions	
AD		Scale 1:2	Sheet 1 / 1
Rev	Description	Date	Vis
			Project No.

Option 2

Schischek designs and delivers the linkage

We can quote you a price for a linkage for any typical valve mounting pattern and stem (for example ISO 5211) without knowing the exact valve dimensions.

When you order the linkage however, we need the dimensions of the top plate / mounting pattern as well as the stem shape and dimensions to design the linkage. The cut sheet for your valve will typically have that information. Simply send us the cut sheet and we will do the rest.

- A -		- B -		- C -		- D -	- E -	- F -	- X -	- Y -	- Z -
Square	Two flat	Fitting key	Flange type DIN 5211	Thread	Hole diameter	Height	Flange thickness	Distance	Torque	Nominal size	Material
9	9	12	F03	M	mm	mm	mm	mm	Nm	DN	standard
		14	F04	UNC	Zoll	Zoll	Zoll	Zoll	lb-in	Zoll	VA
		18	F05	UNF	Zoll						AISI 316
		22	F07								
			F10								
			F12								
		Other	Other								
		mm									
		Zoll									

Increment			
mm	mm		
Zoll	Zoll		

Customer	Country	Project
Actuator type	Armature	
	Type	Manufacturer

Title		ExMax on ball valve	
List of parts	Project	Actuator	Signed
Substitute for	Actuator	ExMax	Checked
Origin	Origin		Approved
Schischek GmbH Mühling 45 Gewerbegebiet Süd 5 D-90579 Langenzem		Drawing No.	Rev
		2011.070.E0-USA	
AD		Scale 1:1.5	Sheet 1 / 1
Rev	Description	Date	Vis
			Project No.



Certification with highest protection classes

ATEX • IECEX • IP66 • INMETRO • KOSHA • CSA • UL • EAC • DNV-GL



ATEX is a commonly used synonym for the ATEX directives of the European Union. The name is derived from the French term "ATmosphère EXplosible". The directive encompasses explosion protection directives 2014/34/EU for equipment and 1999/92/EG for work areas. ATEX directives are devised by the Director General of the EU commission Enterprise and Industry in cooperation with the member states, standardization organizations (CEN, CENELEC) and so called "Notified Bodies" such as BAM, PTB, or TUEV to name examples from Germany.



IECEX is an internationally used process to certify electrical equipment used in hazardous locations. The code defines a system to classify locations with potentially explosive atmospheres caused by gases, dusts, or fibers for example. The main goal of the International Electrotechnical Commission IEC with the IECEX regulation is to reach global harmonization of codes governing use of electrical apparatus in hazardous locations. IEC promotes mutual acceptance of evaluations and reports among the testing labs and certifying bodies.



IP66 stands for Ingress Protection and denotes the protection of the device against environmental factors, dust and rain for example, as well as protection of living beings against dangers of touching high voltage circuits for example. The first digit categorizes ingress of solid objects, the second ingress of water:

- IP6X = dust proof
- IPX6 = water jet proof (with specifies water pressure etc.)



INMETRO (National Institute of Metrology, Quality and Technology) is Brazil's government body responsible for the implementation of measurement, safety and quality standards for electrical and electronic products. It guides the activities of accreditation, inspection, testing and certification bodies in the country.



KOSHA (Korea Occupational Safety and Health Agency) aims to contribute to the national economy by maintaining and improving the safety and health conditions at work through the efficient implementation of projects such as research and development, promotion of industrial accident prevention technologies, provision of technical assistance and training on occupational safety and health, inspection on dangerous facilities and equipment.



Certification with highest protection classes

ATEX • IECEX • IP66 • INMETRO • KOSHA • CSA • UL • EAC • DNV-GL



CSA is a global provider of testing and certification services. CSA is also on the OSHA list of nationally recognized testing laboratories, NRTL.



UL is an independent organization that tests and certifies products with regards to safety. UL tests and evaluates compliance of products, components, materials, and systems against specific requirements. As a result the UL mark can be carried as long as the standards are complied with. UL is one of the OSHA endorsed testing labs. OSHA is the Occupational Safety and Health Administration and maintains a list of labs called NRTL, short for nationally recognized testing laboratories.

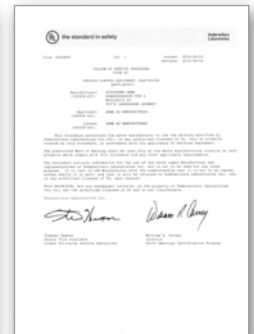

In the context of the Customs Union consisting of Russia, Belarus and Kazakhstan, new technical rules were continuously introduced since June 12, 2012 in order to create a common economic area. This also affects equipment intended for use in potentially explosive atmospheres. As part of this change, the GOST-R Explosion protection certificate was replaced by the new technical regulation TR CU 012/2011 "On the safety of equipment for use in potentially explosive atmospheres". Instead of the previously required GOST-R Ex certificate, it is now necessary to obtain a EAC certification. Likewise, the RTN approval process has been replaced by the TR CU regulations.



DNV GL offers classification and certification of ships as well as technical assurance along with independent expert advisory services for the oil & gas and energy industries. As a classification society they set technical rules for design and construction of ships and issues them as design rules. Design rules do not only contain strength calculations for design and dimensioning of ship constructions but also technical requirements for installed equipment.

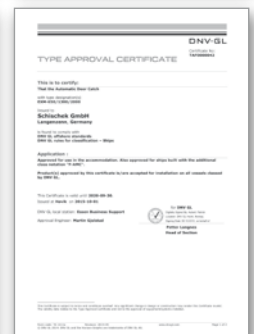



## Information about electrical explosion protection according to ATEX directives \*

### Regulations for explosion protection

#### ATEX

Since July 01, 2003 the rules of explosion protection in the EU are set out by directive 94/9/EC (as of April 20, 2016: 2014/34/EU) concerning equipment and protective systems for use in potentially explosive atmospheres. The aim was to replace national provisions in favor of uniform EU-wide rules and regulations to establish uniform safety standards and to eliminate barriers to trade. In 1996, directive 94/9/EC (as of April 20, 2016: 2014/34/EU) was transposed into German law by the German Equipment Safety Act (recast: Product Safety Act) and the Act on Explosion Protection, in short ExVO (11th GPSGV). While directive 94/9/EC (as of April 20, 2016: 2014/34/EU) defines construction requirements, i.e. it is of particular interest to manufacturers of explosion-proof equipment, operators of installations have to observe directive 1999/92/EC for the safety of workers endangered by explosive atmospheres. In Germany, this directive is transposed into German law by the Industrial Safety and Health Act (BetrSichV).

On April 20, 2016, the ATEX directive 94/9/EC will be replaced by the new directive 2014/34/EU. Many changes in the new directive are not relevant for manufacturers of explosion-proof equipment. Most of the essential content remains the same, for example, Annex I "Criteria determining the classification of equipment-groups into categories" and the essential health and safety requirements (EHSR; Annex II) of the directive do not change. Important for both manufacturers as well as operators and plant manufacturers is that EC-type examination certificates issued in accordance with directive 94/9/EC are still valid. A recertification according to directive 2014/34/EU is therefore not required.

#### ExVO

Directive on the distribution of equipment and protection systems for potentially explosive areas – explosion protection ordinance 11.GSGV.

#### Ordinance on Industrial Safety and Health

Ordinance concerning the protection of safety and health in the provision of work equipment and its use at work, concerning safety when operating installations subject to monitoring and concerning the organization of industrial safety and health at work.

#### Certificates

Corresponding approvals and certificates are required for electrical explosion protected equipment. Testing must be carried out by an official testing agency (Notified Body, for example the PTB, Physikalisch Technische Bundesanstalt in Braunschweig/Federal German Physical and Technical Institute in Braunschweig). ATEX approvals are also accepted in many countries and states outside Europe.

### The type plate and its components

#### Responsibilities

The responsibility for compliance with all regulations and directives, from production and planning to installation, operation and maintenance, has greatly increased.

Each individual must be clear on the fact that he accepts personal responsibility as part of an overall project:

- building owners
- end-users
- architects
- consulting engineers/control companies
- inspection authorities
- contractors/installers
- manufacturers
- product suppliers
- maintenance engineers

#### Example, for the labelling of a quarter turn actuator

Manufacturer's name, manufacturer's address, designation of type, electrical data (V, A, W, Hz) ambient temperature if different from -20 to +40°C, unit serial number, in addition to the classification of Ex protection.



### Correct installation

For the installation of electrical systems in areas with explosive atmospheres of group II, standards IEC 60 079-14 (EN 60079-14) or VDE 0165 apply. In Germany however solely the Technical Rules for Occupational Safety grant the presumption of conformity with the Industrial Safety and Health Act (BetrSichV).

#### Electric circuits of protection types d, e, q, o, m, p

Installation in the control panel is identical to "standard" installation, however the procedures for connecting Ex equipment must be followed. This relates, for example to voltage, current, fuses and motor protection equipment, etc. The requirements for specific products need to be taken from their corresponding test certificates, standards and regulations as well as from the user manual. It is only permitted to work on electric circuits within the Ex-area (for example when making connections in an Ex-e terminal box) when the voltage has been switched off. An Ex-e terminal box should only be opened after the voltage has been switched off.

#### Electric circuits of protection type "i" (intrinsic safety)

For the planning and operation of switchgears and control systems installed in the safe area, but which contain circuits leading into the Ex-area, certain requirements need to be considered. This applies

especially to intrinsically safe circuits. Intrinsically safe circuits and non-intrinsically safe circuits need to be separated. Minimum distances (tight string length) between bare connections must be observed, the cables must not produce any inadmissible external inductance or capacitance. The maximum admissible electrical limits of Ex-i equipment must be observed at all times. Intrinsically safe and non-intrinsically safe electrical circuits may not be connected together. Connections between two different intrinsically-safe circuits are permitted on the condition that a calculation shows that intrinsic safety is not compromised.

Intrinsically-safe circuits have to be marked as such. When marking is done by means of colors, "light blue" color has to be used. This colour is recommended for all intrinsically safe circuits to prevent confusion and/or connection to a non-intrinsically safe circuit. Examples: cables, wiring, cable conduits, terminals, terminal boxes, cable glands ... A minimum distance of 50 mm between intrinsically safe and non-intrinsically safe circuits has to be maintained, and a minimum distance of 6 mm between two different intrinsically safe circuits. During installation the cables of intrinsically safe and non-intrinsically safe circuits are to be routed separately!

#### Suggestion on how to design a panel

It is necessary to keep intrinsically safe and non-intrinsically safe equipment separate. It is recommended, in this case, that a sufficient distance be kept, to avoid extra costs in the future.

Large transformers, frequency converters, large relays and other electric equipment that may influence intrinsically safe circuits by inductance or capacitance should be installed at a sufficient distance. As a precaution Ex-i equipment should have a suitable cover to protect it from incorrect handling. The appropriate standards and regulations must be observed.

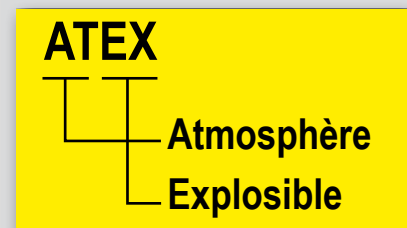

\* from April 20, 2016 replacement of ATEX 94/9/EC directives with directives according to ATEX 2014/34/EU



## Labelling of explosion proof equipment according to ATEX 2014/34/EU

### Classification and labelling of hazardous locations

Flammable medium	Hazardous locations Probability of a potentially explosive atmosphere occurring	Classification of hazardous locations	Product classification		Equipment protection level (EPL)
			Product group	Product category	
Gases, mists, vapours	Continuously, for long periods or frequently	Zone 0	II		
	Likely to occur	Zone 1	II	1G	Ga
	Infrequently and for short periods only	Zone 2	II	2G 3G	Gb Gc
Dusts	Continuously, for long periods or frequently	Zone 20	II		
	Likely to occur	Zone 21	II	1D 2D	Da Db
	Infrequently and for short periods only	Zone 22	II	3D	Dc

### Classification Explosion groups & Temperature classes

Explosion group	Examples depending on - explosion group - temperature class
IIA	Ammonia, Methane, Ethane, Propane
IIB	Ethanol, Cyclohexene, n-Butane
IIC	City gas, Acrylic nitrile, Hydrogen
	Petrol, Diesel fuel, Fuel oil, n-Hexane
	Ethylene, Ethylene oxide, Acetylene
	Ethyl glycol, Carbon hydrogen, Ethyl ether
	Carbon disulphide

Temperature class	Attention: this list is only an extract of possible flammable mediums and does not claim to be complete!
T1 < 450°C	
T2 < 300°C	
T3 < 200°C	
T4 < 135°C	
T5 < 100°C	
T6 < 85°C	

Product use depending on temperature class (T1 - T6). The temperature class indicates the max. temperature of the exposed surface of the product. For dust explosion proof, the max. surface temperature is directly shown (e.g. T80°C).

Notified bodies	
Code number	Notified Body (NB)
0102	PTB (Germany)
0158	EXAM (Germany)

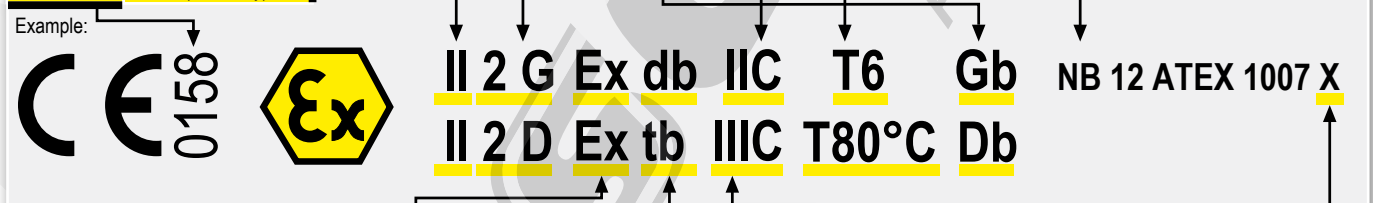

Protection principle	Type of protection	Code	Symbol	To use in zone	CENELEC
Prevents transmission of the explosion outside	flameproof enclosure	Exd	da db dc	0,1,2 1,2 2	EN 60079-1
Prevents high temperatures and sparks	increased safety	Exe	eb ec	1,2 2	EN 60079-7
Low current/voltage supply	intrinsic safety	Exi	ia ib ic	0,1,2,20,21,22 1,2,21,22 2,22	EN 60079-11
Positive pressure device	pressurised apparatus	Exp	pxb pyb pzc	1,2,21,22 1,2,21,22 2,22	EN 60079-2
Encapsulated	moulding	Exm	ma mb mc	0,1,2,20,21,22 1,2,21,22 2,22	EN 60079-18
Parts immersed in oil to isolate from explosive atmosphere	oil immersion	Exo	ob oc	1,2 2	EN 60079-6
Prevents transmission of explosion outside	powder filling	Exq	qb	1,2	EN 60079-5
As above, but for use in zone 2	protection "n"	Exn	nC nR	2 2	EN 60079-15
Dust explosion proof	protection by enclosure	Ext	ta tb tc	20,21,22 21,22 22	EN 60079-31

Code	Dust classification
IIIA	flammable fibres
IIB	non conductive dust
IIC	conductive dust

IP	Protection against solids/dust	Protection against water
8	-	long periods of immersion
7	-	the effects of temporary immersion
6	totally protected against dust	strong jets of water
5	dust - limited ingress	low pressure jets from all directions
4	solids objects > 1 mm	sprays from all directions
3	solids objects > 2,5 mm	direct sprays up to 60° from vertical
2	solids objects > 12,5 mm	direct sprays up to 15° from vertical
1	solids objects > 50 mm	vertical falling drops of water
0	no protection	no protection

Application	Code
For common use	-
For use under special conditions	X
This part is an Ex component and certified as such and is therefore not suitable for use on its own	U

## Where and when do I have to take explosion proof into consideration ?

Explosion proof means: "Protection of Life. Health. Assets."

### When does the danger of an explosion occur?

A danger of explosion occurs when a flammable medium (gas, vapor, mist or dust) is present in a dangerous quantity.

### When does an explosion occur?

An explosion may occur when the following 3 components are present at the same time:

- Flammable or combustible media
- Oxygen
- Source of ignition

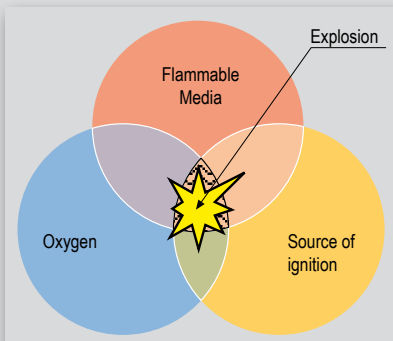

### Typical sources of ignition

Very often the cause of an accident is self-ignition, hot surfaces and mechanically generated sparks. But there are also a lot of other sources of ignition, caused by either mechanical and/or electrical equipment:

- Self-ignition
- Extraordinary surface temperatures
- Open flames
- Mechanically generated sparks
- Static electricity
- Lightning strike
- Ultra-sonic
- Chemical sources of ignition
- Electric sparks
- Electric arcs
- Adiabatic compression
- Adiabatic shock waves
- Electric circulating currents

### Is your system safe?

**We have the following situation NOW or in the FUTURE:**

Yes.No (Please check)

- Flammable materials are stored.
- Flammable materials are used.
- Flammable materials are bottled.
- Flammable materials are used during the cleaning process.
- Flammable materials are used in the production process.
- Flammable materials will be produced during the production process.

6 x "No": Obviously you do not need explosion protection

at least 1 x "YES":  
When planning you have to consider rules, regulations and instructions concerning explosion protection

**Example: ATEX directives, EN 60079-14**

### Remarks:

All information, tables, checklists and further documentation are only for your assistance and do not claim to be complete. In no way do they replace official regulations and rules or even laws by the authorities. We want to point out that it is very important to undertake all measures for an exact classification of the Ex-area.

### Typical Applications:

- Chemical, pharmaceutical and industrial plants
- Refineries, petrol depots, gas stations
- Paint and solvent shops
- Drying and coating cabinets
- Laboratories in industry and schools
- Water treatment works, power plants
- Compressor stations, gas works
- All kinds of storekeeping and stocks
- All kinds of filling stations
- All kinds of cleaning stations
- Mills, silos, silos for bulk goods
- Offshore and onshore
- Oil and gas pipelines
- Printing works, food industry, ...

### Schedule:

- Analyse whether you need explosion protection or not
- Ask experts in order to analyse the risk
- Define zones, areas, categories, explosion groups and temperature classes
- Planning according to all necessary rules and regulations
- Choose the best supplier and the right product
- Keep to the installation rules
- Check the labelling of the equipment
- Make sure that the appliance will be put into operation correctly
- Confirm a final inspection by the responsible authority
- Guarantee regular and correct maintenance according to the regulations
- The correct documentation has to be maintained

### From combustion to detonation

Effect and reaction velocity increase significantly from combustion, deflagration, via explosion up to detonation. Explosions are more likely with gaseous media and detonations with dust media.

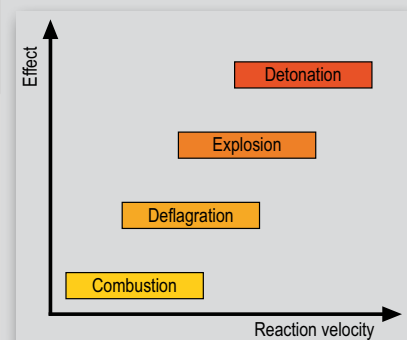



Zones • Explosion groups • Temperature classes

Introduction

Areas with potentially explosive atmospheres are divided into zones, equipment has to be divided into groups and categories. The marking on the identification plate of certified equipment indicates in which zone the explosion protected equipment can be used.

**Division into product groups**

Equipment is divided into group I and group II. Group I deals of underground mines and group II deals with all other applications.

**Division into zones**

Areas with potentially explosive atmospheres are divided into six zones according to the probability of how frequent and for which period of time a potentially explosive atmosphere (p.e.a.) exists.

A distinction is made between combustible gases, mists, vapors and combustible dust. For gases, mists and vapors zones 0, 1 and 2 exist, in which the requirements for the chosen equipment increase from zone 2 to 0. Equipment in zone 0 must be built in a way "that even if a type of protection fails or if two faults occur, that sufficient explosion protection is guaranteed". Therefore for example a passive, potential free sensor, installed in zone 0, and connected to an intrinsically safe electric circuit (II 2 (1) G [Ex ia] IIC), needs its own approval. Zones 20, 21 and 22 are for dust atmospheres, in which the requirements for the chosen equipment increase from zone 22 to 20. Equipment in zone 20 and 21 need special approval.

**Division into equipment groups**

Equipment groups determine, in which zones the equipment may be installed. Once again there are six categories. Categories 1G, 2G and 3G are classifications for gas explosion protection (G = Gas); thereby 1G equipment is suitable for use in zones 0, 1 and 2, 2G equipment is suitable for use in zones 1 and 2 and 3G equipment is suitable for use in zone 2. Categories 1D, 2D and 3D are classifications for dust explosion protection (D = Dust); thereby 1D equipment is suitable for use in zones 20, 21 and 22, 2D equipment is suitable for use in zones 21 and 22 and 3D equipment is suitable for use in zone 2.

Classification and labelling of hazardous locations

Flammable medium	Hazardous locations Probability of a potential explosive atmosphere occurring	Classification of hazardous locations	Product classification		Equipment protection level (EPL)
			Product Group	Product Category	
Gases Vapours Mists	Continuously, for long periods or frequently	Zone 0	II	1G 2G 3G	Ga Gb Gc
	Likely to occur	Zone 1	II		
	Infrequently and for short periods only	Zone 2	II		
Dusts	Continuously, for long periods or frequently	Zone 20	II	1D 2D 3D	Da Db Dc
	Likely to occur	Zone 21	II		
	Infrequently and for short periods only	Zone 22	II		

**Zone 0, 1 and 2**

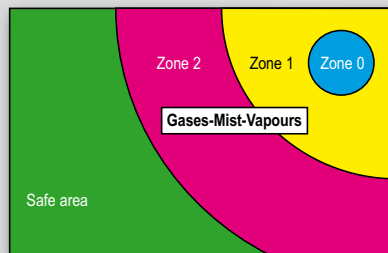

An example of a typical zone distribution would be filling a barrel of petrol in an enclosed area.

**Zone 20, 21 and 22**

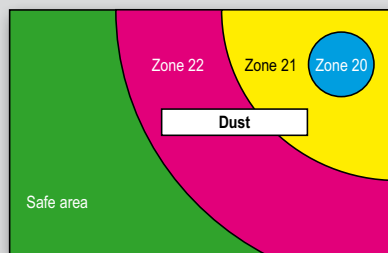

An example of a typical zone distribution would be filling a grain silo in an enclosed area.

**Explosion groups, temperature classes**

The equipment groups and categories determine, in which zones the equipment may be installed, whereas the explosion groups and temperature classes determine, for which mediums inside the zones, the equipment is suitable. The type of protection used is not a mark of quality but is instead a constructive solution for selecting equipment for explosion protection.

**Division into explosion groups**

Explosion protected equipment for gases, mists and vapors is divided into three explosion groups (IIA- IIB- IIC) according to the type of protection being used. The explosion group is a means to measure the ignitability of gases (potentially explosive atmospheres). The equipment requirements increase from IIA to IIC.

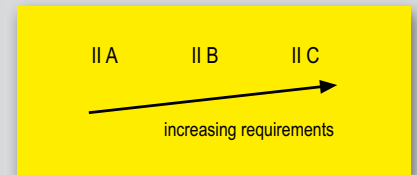

**Division into temperature classes**

Explosion proof equipment, installed within an Ex area, is divided into 6 temperature classes (T1 to T6). The temperature class is not – as it is often wrongly believed – the operating temperature range of the equipment, but the maximum permissible surface temperature of the equipment, in relation to + 40°C ambient temperature on any surface area, which may not be exceeded at any time. The maximum surface temperature must remain below the ignition temperature of the surrounding medium at all times. The equipment design requirements increase from T1 to T6.

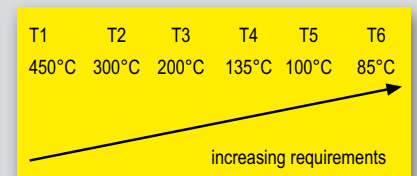



Ex applications

Air safety dampers • Air control dampers • Fire / smoke dampers

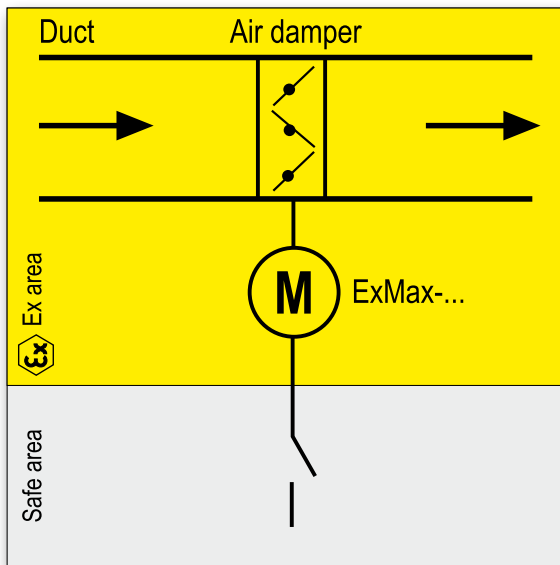

**Air damper control**

Schischek actuators are approved for direct installation and operation in explosive atmospheres, as they are of the highest explosion groups and temperature class and are suitable for all gases, mists, vapors and dust.

During installation please ensure that all cables are securely fixed and connected in such a way that they are protected from mechanical damage. For electrical connection an explosion protected terminal box (type ExBox-...) has to be used.

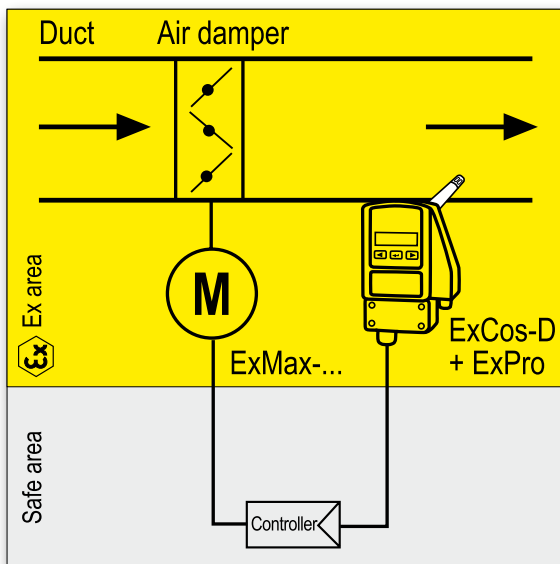

**Automatic air damper control**

In this example the control system consists of an actuator and an Ex-Cos-D transmitter with ExPro sensor. The combination can be installed directly in an Ex area. The transmitter converts the sensor signal into an active signal (0...10 VDC or 4...20 mA) for input in a PLC system. The output signal from the controller goes directly to the actuator.

Between sensor and controller an additional Ex-i module and intrinsically safe (IS) circuit wiring are not required. For the actuator and transmitter the maximum permissible surface temperatures have to be taken into account.

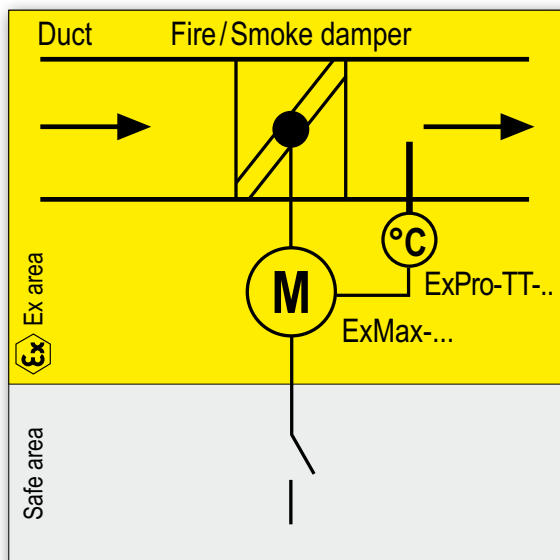

**Control of fire / smoke dampers**

In applications for fire / smoke dampers, the actuator has to reliably return the damper to its safety position via an external switch / contact.

The actuator closes the damper mechanically by means of an internal spring. The closing operation is triggered by a safety thermal trigger of type ExPro-TT-...

Ex applications

Heating • Cooling • Humidification • Diff.pressure control • VAV

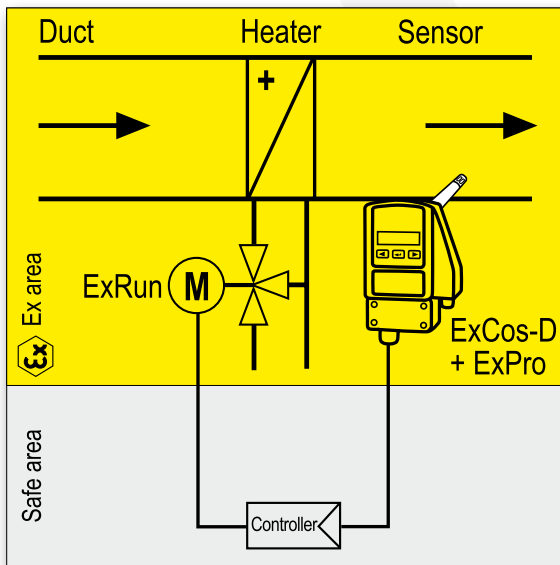

**Heating/cooling control**

In this example the control system consists of an actuator and an ExCos-D transmitter with ExPro sensor. The combination can be installed directly into an Ex area. The transmitter converts the sensor signal into an active signal (0...10 VDC or 4...20 mA) for input in a PLC system. The output signal from the controller goes directly to the actuator.

Between sensor and controller an additional Ex-i module and intrinsically safe (IS) circuit wiring are not required. For the actuator and transmitter the maximum permissible surface temperatures have to be taken into account.

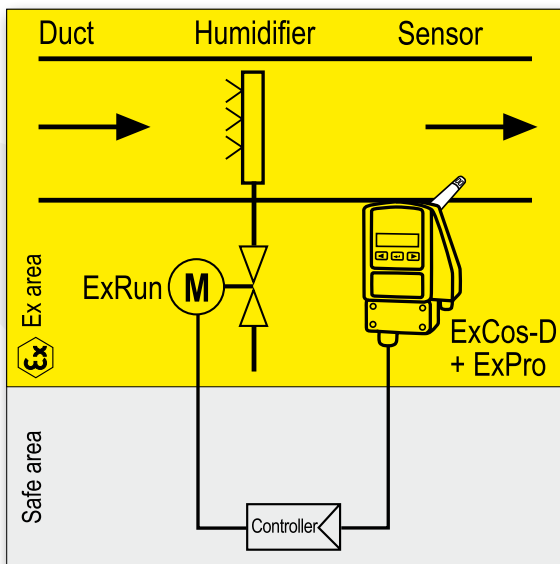

**Humidity control**

In this example the control system consists of a valve actuator and an ExCos-D transmitter with ExPro sensor. The combination can be installed directly into an Ex area. The transmitter converts the sensor signal into an active signal (0...10 VDC or 4...20 mA) for input in a PLC system. The output signal from the controller goes directly to the actuator.

Between sensor and controller an additional Ex-i module and intrinsically safe (IS) circuit wiring are not required. For the actuator and transmitter the maximum permissible surface temperatures have to be taken into account.

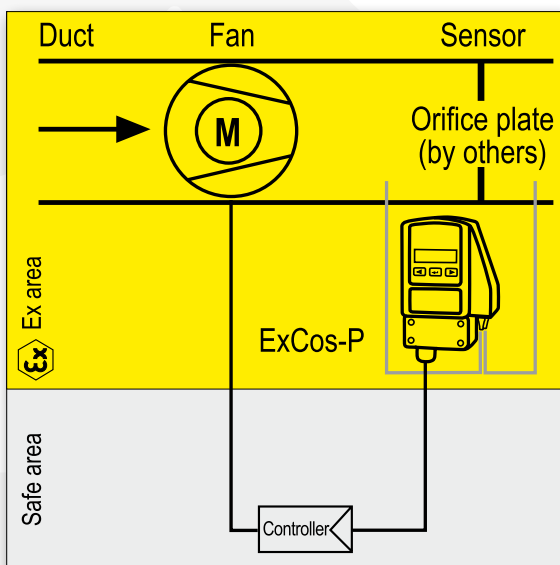

**Differential pressure control/VAV**

In this example the control system consists of an actuator and a differential pressure ExCos-P transmitter. The combination can be installed directly in an Ex area. The transmitter converts the differential pressure signal into an active signal (0...10 VDC or 4...20 mA) for input in a PLC system. The output signal from the controller goes directly to the actuator.

Between sensor and controller an additional Ex-i module and intrinsically safe (IS) circuit wiring are not required. The controller is located in the safe area and delivers an output signal for example via a frequency converter to control a fan (must be Ex protected) or a modulating damper actuator (also Ex protected) to maintain the required air volume/pressure. The technical specifications can be found in the approval documents.

## Ex applications

Thermostats • Humidistats • Pressostats • Filter monitoring

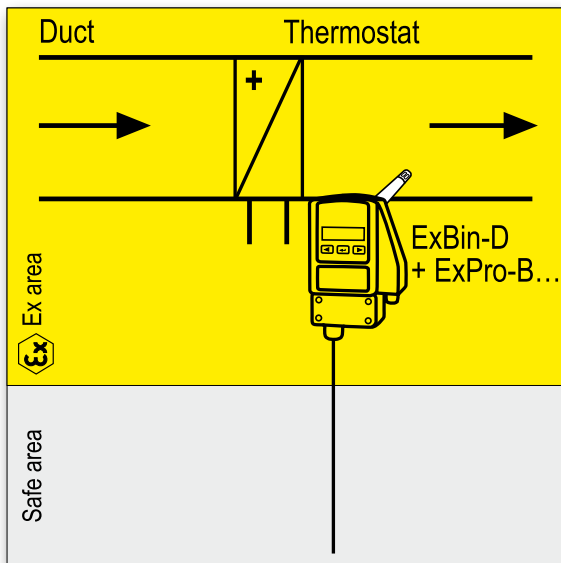

### Thermostats

ExBin-D... modules with ExPro-BT... sensor are thermostats for use in potentially explosive atmospheres. No intrinsically-safe electrical circuits and no switching amplifiers need to be installed in the electrical control-panel. The module may be installed directly in an Ex area, depending on demand in zone 1, 2, 21 or 22.

The output contact can be used for follow-up functions (relays, contacts, direct circuit, ...).

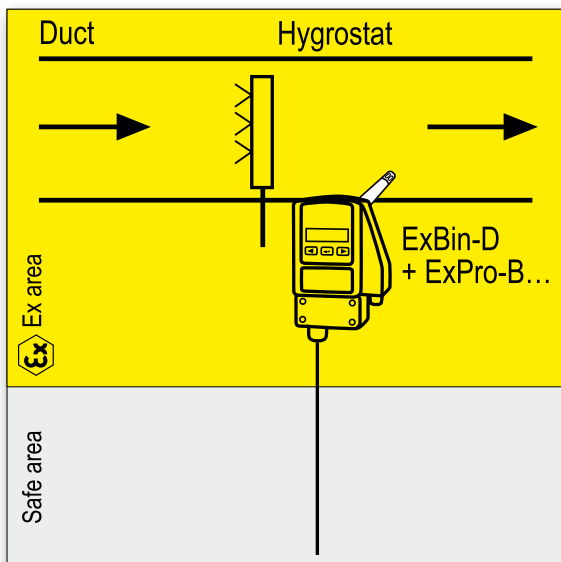

### Hygromats

ExBin-D... modules with ExPro-BF... sensor are hygromats for use in potentially explosive atmospheres. No intrinsically-safe electrical circuits and no switching amplifiers need to be installed in the electrical control-panel. The module may be installed directly in an Ex area, depending on demand in zone 1, 2, 21 or 22.

The output contact can be used for follow-up functions (relays, contacts, direct circuit, ...).

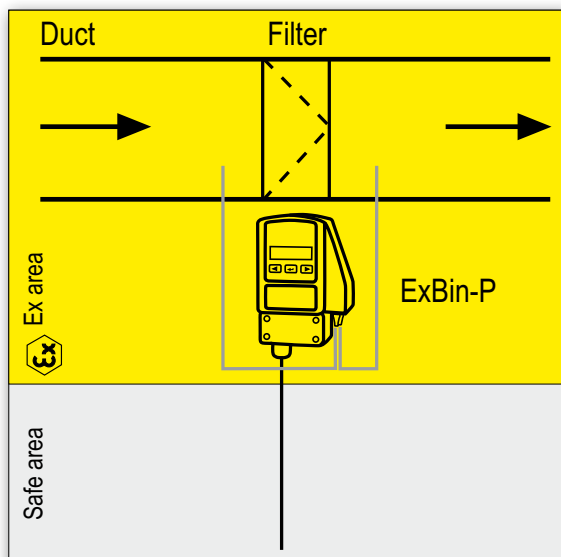

### Filter monitoring

ExBin-P... modules are pressostats like Ex-differential pressure switches, e.g. for filter monitoring in potentially explosive atmospheres. No intrinsically-safe electrical circuits and no switching amplifiers need to be installed in the electrical control-panel. The module may be installed directly in an Ex area, depending on demand in zone 1, 2, 21 or 22.

The output contact can be used for follow-up functions (relays, contacts, direct circuit, ...).

Ex applications

Drive (Fan) belt monitoring • Frost protection

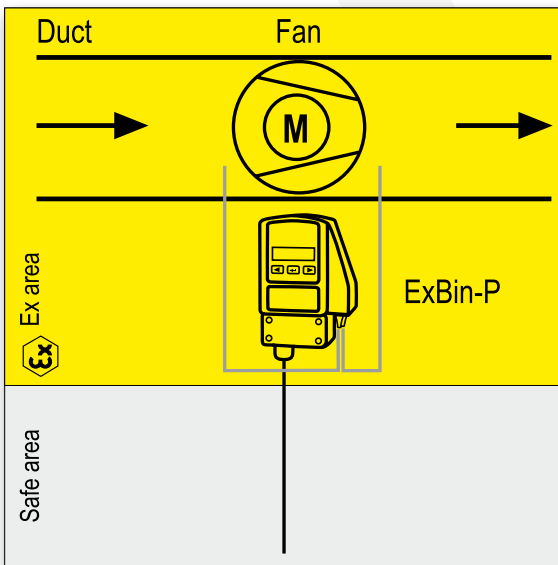

**Drive (fan) belt monitoring via differential pressure**

ExBin-P... modules are pressostats like Ex-differential pressure switches, e.g. for fan belt monitoring in potentially explosive atmospheres. No intrinsically-safe electrical circuits and no switching amplifiers need to be installed in the electrical control-panel. The module may be installed directly in an Ex area, depending on demand in zone 1, 2, 21 or 22. To indicate fan failure switching modules are delivered with integrated time running relay with delay on start up.

The output contact can be used for follow-up functions (relays, contacts, direct circuit, ...).

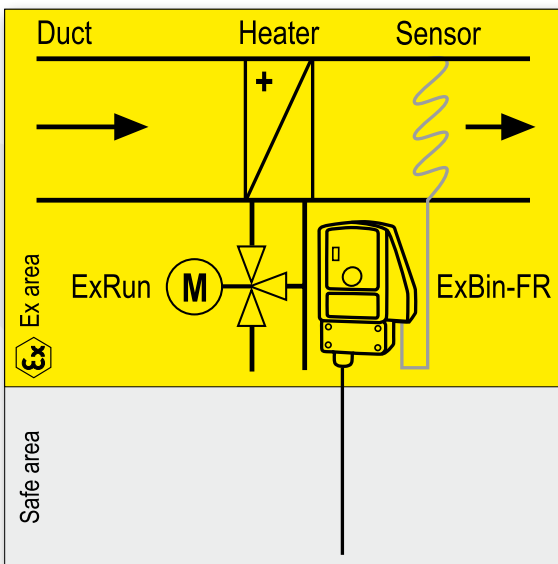

**Frost protection**

ExBin-FR... are sensors for frost protection monitoring with a capillary as measuring element for use in potentially explosive atmospheres. No intrinsically-safe electrical circuits and no switching amplifiers need to be installed in the electrical control-panel. The module may be installed directly in an Ex area, depending on demand in zone 1, 2, 21 or 22.

The output contact can be used for follow-up functions (relays, contacts, direct circuit, ...).

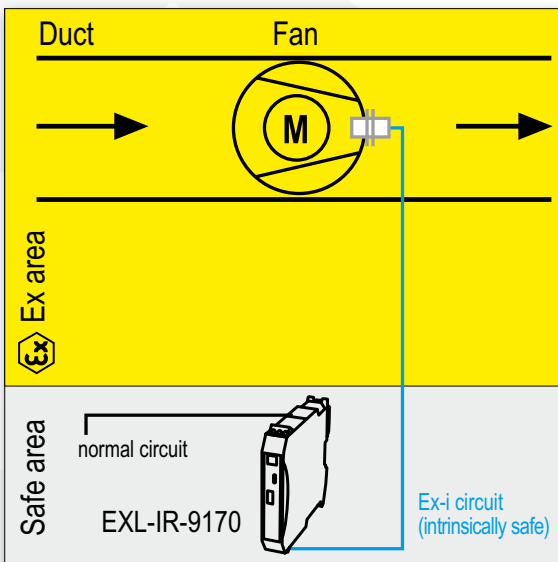

**Fan belt monitoring via Namur sensor**

EXL-IR-9170 switching modules in combination with connected Namur sensor (inductive proximity switch) are suitable for non-contact V-belt monitoring of fans in hazardous locations.

The switching module is installed in the safe area. Wiring is via an intrinsically safe Ex-i circuit. The proximity switch type Namur is installed in the hazardous location, depending on the sensor type and certification in zone 1 or 2.

The input of the switching module is a passive, potential-free, binary signal, the output is a potential-free, switching contact.

# rotork®

## Keeping the World Flowing

Since 1957, Rotork has grown to be a major international business with subsidiaries all around the world.

When you turn on a tap or switch on a light, turn on a kettle or put fuel in your car, a flow control product is being used somewhere in the process of delivering that service.

We are recognised as global leaders, designing and building the most reliable products, backed up by highly acclaimed customer service.

Rotork has established manufacturing facilities, a global network of local offices and agents who can truly provide a worldwide service. You will be able to locally source Rotork's products, supported by life-of-plant maintenance, repair and upgrade services.

## Committed to Innovation

At every stage in the company's history, Rotork's engineers have focused on solving customer challenges and developing new solutions with levels of engineering skill and creativity that our competitors still cannot match.

With every product that Rotork develops, you can be sure of one thing: That quality and reliability are an integral part.

## Serving the World

Rotork has always been committed to global supply, supporting operations in some of the most remote and challenging environments.

We have established manufacturing facilities across the globe which together with our own global network of local offices, regional *Centres of Excellence* and agents provide over 800 Rotork outlets worldwide.

"For over sixty years, engineers have relied upon Rotork for innovative, dependable solutions to manage the flow of liquids, gases and powders. From safety systems that may be needed just once in a lifetime to process controls that are constantly on the move, Rotork flow control products remain the clear choice, worldwide".



## Electric Control Valve Actuators and Gears (Extraction)

### IQT range



#### Multi-turn and part-turn electric actuators

IQT part-turn 1-phase, 3-phase and DC electric actuators are designed for isolating or regulating duties (S2 & S3/Class A & B) of up to 1,200 starts per hour.

- Direct torque output range from 50 to 3,000 Nm
- Continuous position tracking at all times, even without power
- Extended life and mounting in any orientation with oil bath lubrication
- IP66/68 certified
- Safe, motor-independent, handwheel operation available at all times
- Explosionproof and certified for safety applications (SIL2/3) are available

### CK range



#### Modular design electric valve actuators

CK range actuators are suitable for valves in non-hazardous locations. The modular product range facilitates a number of different control package configurations to meet your application requirements.

- Multi-turn output torque up to 10,800 Nm (8,000 lbf.ft)
- Part-turn output torque up to 205,600 Nm (151,600 lbf.ft)
- Modular design provides an off-the-shelf solution for spares and upgrading
- Plug and socket connection for easier field wiring
- Continuous valve position indication even during power loss
- Non-intrusive setting via infrared or optional *Bluetooth*® with the intelligent CKc - Centronik module
- Hollow output drive to accept rising valve stems
- Detachable base options
- Secure manual handwheel drive fully independent of the motor drive train
- IP68 rating (8 m for 96 hrs) as standard provides enhanced environmental protection

### ROM / ROMpak ranges



#### Compact and lightweight part-turn actuators

Electric, compact and lightweight part-turn actuators with efficient and simple gearing.

- Torque range 8 to 800 Nm (6 to 590 lbf.ft)
- On/off duty, manual override, self-locking, ISO flanges
- Available with local controls and phase rotation correction
- Wide range of supply voltages available
- 1-phase, 3-phase and DC power supply options
- Watertight IP68 rating
- High speed variant available
- Mechanical and LED local position indication
- Options: Bus communication, analogue control and feedback

### Gears ... ranges



#### Valve gear operators and accessories

Rotork offer a wide range of gearboxes spanning the following categories:

- Part-turn output manual gear operators
- Part-turn output motorised gear operators
- Multi-turn output manual gear operators
- Multi-turn output motorised gear operators
- Specialised application gear operators
- Mounting kits and accessories



## Electric Control Valve Actuators (Extraction)

### CMA range



CML 1500 (Linear)



CML (Linear)



CMQ (Part-turn)



CMR (Multi-turn)

#### Linear, part-turn and multi-turn actuators

The Rotork CMA delivers a range of sizes suitable for almost all linear, part-turn and multi-turn control valves and other applications requiring exact position control and continuous modulation. Suitable for demanding applications including control valves, metering and dosing pumps.

- CML Linear up to 20 kN (4,500 lbf) seating thrust
- CMQ Part-turn up to 124 Nm (1,100 lbf.in) seating torque
- CMR Multi-turn up to 45 Nm (400 lbf.in) rated torque
- Powered by 1-phase or DC supplies
- Continuous modulation to S9 (IEC 60034), Class D duty (EN15714-2)
- Permanently lubricated and maintenance free drive train

- Accurate and repeatable position control
- 4-20 mA loop powered feedback signal
- Options:
  - local controls including positional display
  - Reserve Power Pack (RPP) including local controls and positional display
  - configurable ESD input for end of travel or stayput emergency shutdown function

### CVA range



CVL (Linear)



CVQ (Part-turn)



CVL-5000 (Linear)

#### Linear and part-turn precision modulating actuators

- CVL Linear: thrust range 890 to 22,241 N (200 to 5,000 lbf)
- CVQ Part-turn: torque range 54.2 to 271 Nm (480 to 2,400 lbf.in)
- Compact, viable alternative technology when good quality instrument air is not available in hazardous areas
- Ultra-low energy consumption, suitable for solar powered applications
- Continuous, unrestricted modulation to S9 (IEC 60034), Class D duty (EN15714-2)
- Unparalleled accuracy, repeatability, resolution and stiffness
- Perfect for demanding applications including control valves and metering pumps
- Comprehensive data logging

- Analogue, digital and network control options
- Watertight IP68, NEMA 4 & 6, explosionproof enclosures
- Non-intrusive setup / calibration using *Bluetooth*® wireless technology
- Options:
  - 1-phase and DC power supply options
  - *Pakscan*™, HART®, Profibus®, Foundation Fieldbus® and Modbus® available
  - Programmable fail-to-position option
  - Hardwired control
  - Intrinsically safe I/O connections
  - Manual override

## Fluid Power Actuators (Extraction)

### K-TORK

range



#### Pneumatic vane actuators

- Pneumatic actuators in double-acting and spring-return configurations
- Compact no-sideload, constant-torque design with output to 18,300 Nm (13,497 lbf.ft)
- Certified to IP66M/IP67M and meets NEMA 4/4X
- Certified to ATEX 2014/34/EU
- Complies with ANSI/AWWA C540-02 and C541-08
- Conforms to VDI/VDE 3845 control accessory mounting standards
- Modulating accuracy of 0.25% or better
- Capable of millions of operations at fast cycle times

### GT/GTS

ranges

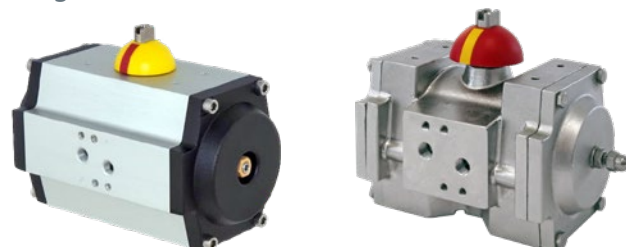

#### Pneumatic rack and pinion actuators

- Double-acting and spring-return pneumatic actuators
- *NEW: now also available in stainless steel (GTS range)*
- Torque output up to 15,300 Nm (GTS range 1,190 Nm)
- Fail close/fail open
- Extruded aluminium body with cast aluminium end caps (GTS range in stainless steel 316L)
- Mechanical interfaces to ISO 5211, EN 15714-3-4, NAMUR VDI/VDE 3845
- Certified to ATEX 2014/34/EU
- Certified up to SIL3 as a single device (IEC 61508) by GT range
- Travel stops in both open and close direction (GTS range)

### RC200

range



#### Compact scotch yoke actuators

- Extremely compact scotch yoke pneumatic actuator
- Torque output up to 4,400 Nm (3,245 lbf.ft)
- Contained spring module for safety and convenience
- Double-acting and spring-return configurations
- Fail close/fail open
- For on/off and modulating
- Valve mounting dimensions per ISO 5211/DIN 3337
- Certified to ATEX 2014/34/EU
- Certified to PED 2014/68/EU
- Suitable for use at SIL3 as a single device in accordance with IEC 61508
- Optional emergency manual override suitable to operate the actuator in the event of fluid supply failure

### Skilmatic SI

range



#### Electro-hydraulic actuators

- 1-phase, 3-phase or 24 VDC power supply
- Linear output up to 5,500 kN (1,236,000 lbf)
- Part-turn output up to 500,000 Nm (368,781 lbf.ft)
- Configurable Partial Stroke Testing (PST)
- Failsafe to close, open or lock in last position
- Spring-return or double-acting
- Configurable via *Bluetooth*<sup>®</sup>
- Data logger, recording up to 3,000 events
- Watertight and explosionproof according ATEX, IEC and EAC, TÜV Functional Safety SIL certified to IEC 61508:2010
- Operating temperature  $-50\text{ °C}$  to  $+70\text{ °C}$  ( $-58$  to  $+158\text{ °F}$ )
- Network options *Pakscan*<sup>™</sup>, Profibus<sup>®</sup>, Modbus<sup>®</sup>, HART<sup>®</sup> and Foundation Fieldbus<sup>®</sup>
- Positioning control option 4-20 mA input and output, resolution 0.3%

## **rotork®** Site Services

Rotork Site Services provide our customers with the extensive onsite technical expertise required to ensure the successful functioning of installations anywhere around the globe.

We provide a comprehensive selection of programs around the topic Flow Control:

- Emergency service and scheduled service
- Actuator overhauls
- Status checks
- Preventive maintenance
- Installation of actuators on existing valves
- Plant shutdowns
- Certified inspection and safety checks
- Factory assembly of actuators to new valves
- Plant optimization
- Repairs and upgrades
- Rental service of actuators
- System automation projects
- Advanced automation projects

**„In each of our business areas our Site Services Team is dedicated to customer service and support from the commissioning of new installations and supporting customised automated processes to implementing retrofit packages. The teams are available in service centers worldwide and are supplemented by factory-trained specialists“.**





## High Plant Availability through Preventative Maintenance

Rotork actuators are recognised as the best in the world for reliability and safety in the most demanding applications. To maintain this hard-earned leadership position, Rotork is committed to helping clients to maximise the continuous, fault-free operation and working life of all their actuators.

Rotork have over 60 years of flow control experience with expertise in all actuation applications. Let Rotork leverage this expertise during your planned maintenance periods to maximise operating efficiency of your site while reducing shutdown duration and frequency.

"Rotork actuators incorporate intelligence to satisfy the increasing requirements of actuation, now and in the future. Intelligent Asset Management makes it easy to identify potential issues, plan predictive maintenance and improve your operating processes".





# Damper Actuation Focused



Switch boxes  
and position indicators



Electric actuators with  
or w/o spring return



Temperature triggers  
for fire-dampers



Manual operators

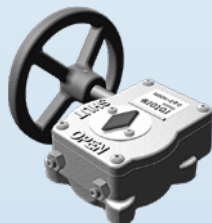

## One Air-Damper – Various Actuator Solutions!



Pneumatic control components and air preparation



Pneumatic actuators such as rack and pinion, scotch/yoke, vane, electro-hydraulic



Spring assembly

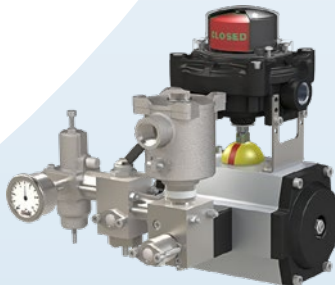

Positioners



Rotork  
hvac@rotork.com  
+49 9101 9081-15

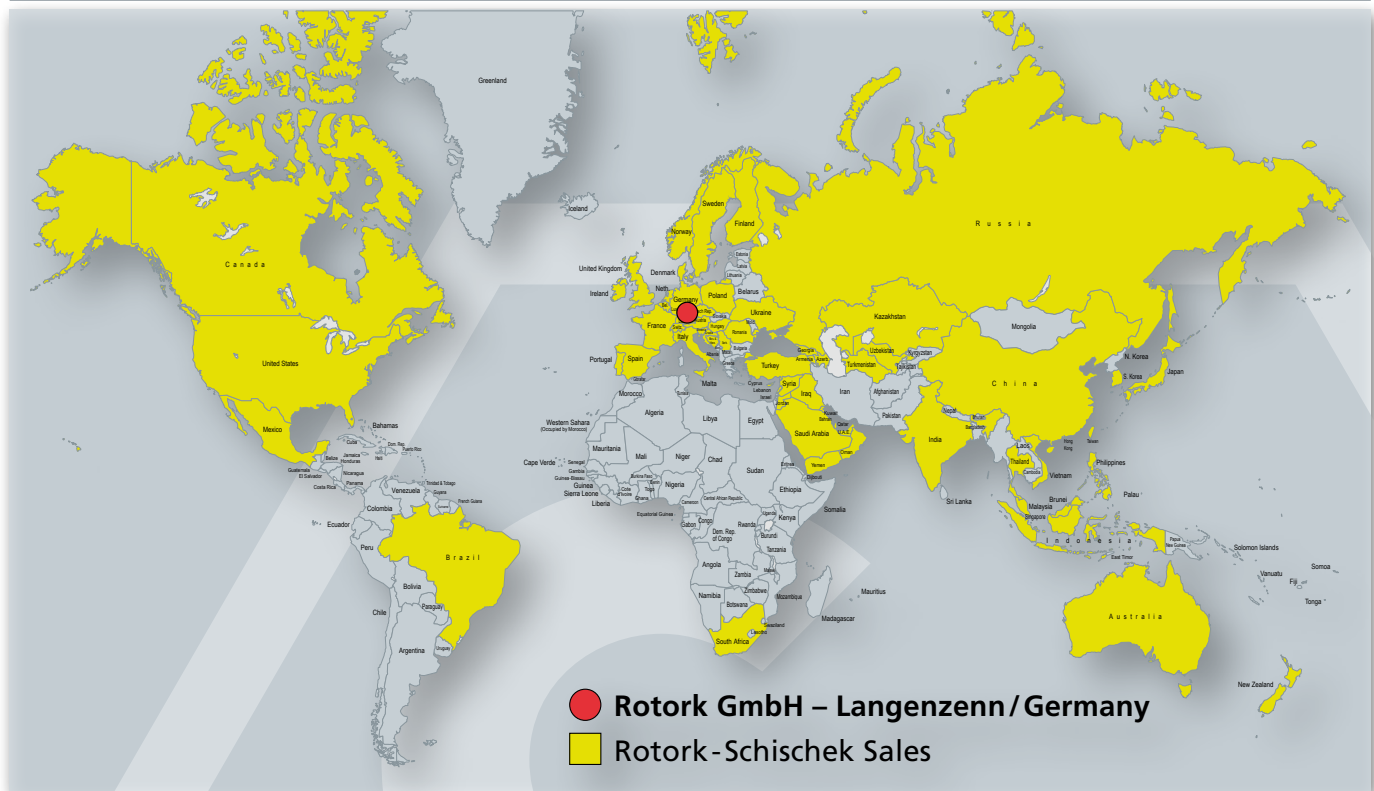

**Rotork - Schischek Sales Worldwide****Contact****Rotork GmbH**

Muehlsteig 45  
90579 Langenzenn  
Germany  
Tel. +49 9101 9081-0  
Fax +49 9101 9081-77  
info@schischek.com  
www.schischek.com

**Your Local Dealer**

To find your local contact please visit:  
[www.schischek.com/contact/rotork-schischek-worldwide](http://www.schischek.com/contact/rotork-schischek-worldwide)  
[www.rotork.com/en/contact-us/sales-service-locator](http://www.rotork.com/en/contact-us/sales-service-locator)